

STARTT

(Assembling Guide supplied by **iMakr**)
with the support of **MyMiniFactory.com**

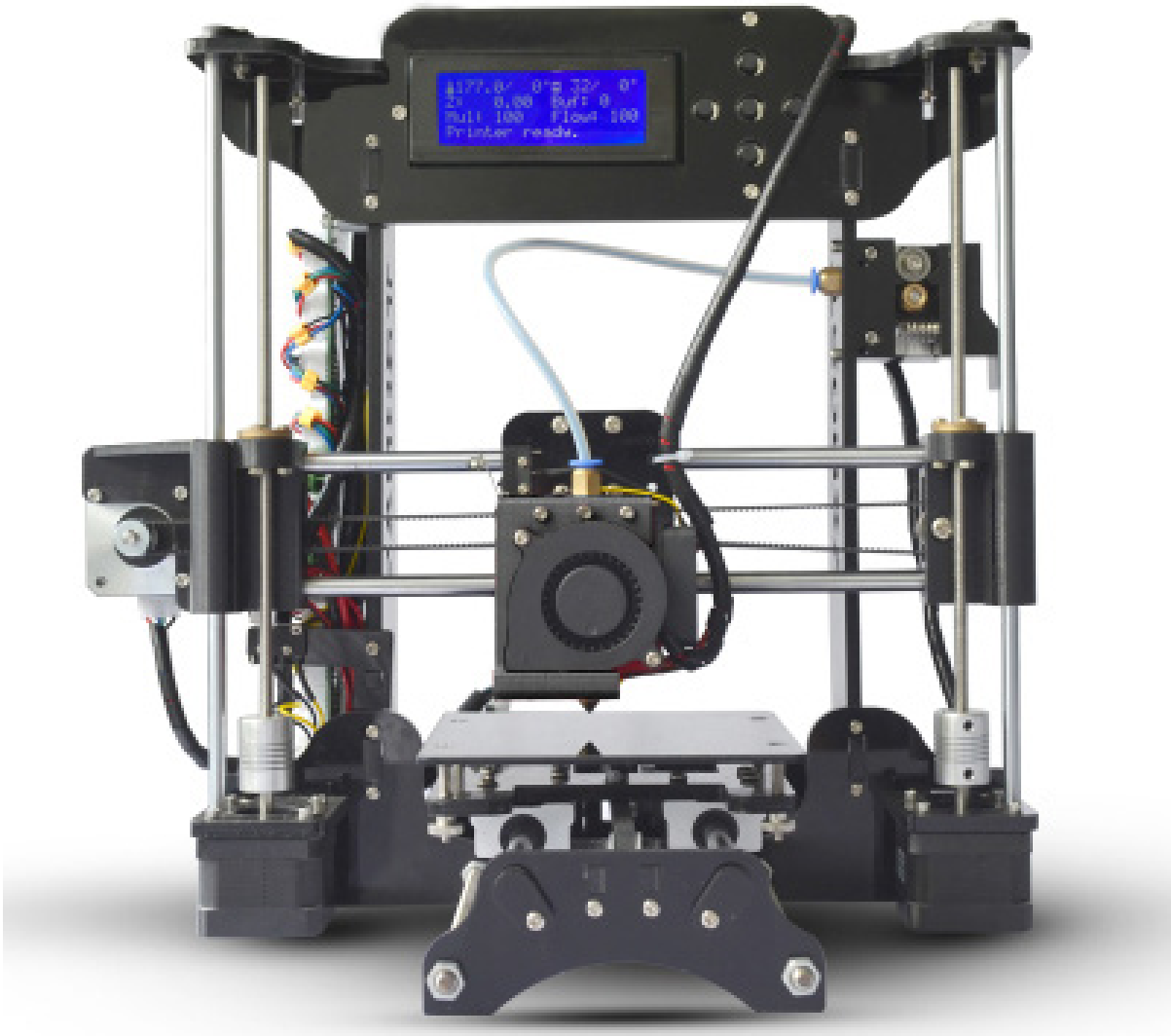

Summary

Congratulations on beginning on your journey into 3D printing with the STARTT 3D printer.

In this guide, you will have a thorough breakdown of how to correctly assemble your STARTT 3D printer.

Your STARTT is compatible with PLA filaments with 1.75mm diameter and can print dimensions up to 12cm x14cm x13cm.

What to Remember

No soldering required!

Everything needed for assembly is supplied inside the box!

No specific skills are required!

When you're done assembling, you can find cool content to print on MyMiniFactory's [STARTT profile page](#). MyMiniFactory.com is the world leading 3D printable object-sharing platform where you can download thousands of beautiful objects for free.

This guide is also available in video at the following link:

www.imakr.com/startt/video

For French version of the guide:

www.imakr.fr/startt

www.imakr.fr/startt/video

You can expect to spend between **4 - 5** hours on assembly.





Have fun and let's get started!

Preparation

Before you start building your machine, please locate the screw pack. It contain different types of screws required for the assembly.



The picture below shows you how to differentiate the screws and thenuts. M2 being the thinnest and M5 being the thickest.

M2	M3	M4	M5
20mm	10mm 20mm 25mm	10mm	
			
			

Step 1: Assemble Y-Axis Motor (4 - 10 mins)

Parts Required

				
Acrylic Piece 1	Acrylic Piece 2	Stepper Motor	M3 Nut x 1	M3 10mm Screw x4
				
				M3 20mm Screw x1

1) Place M3 nut x1 in the gap of 'Acrylic Piece 1' as shown in the picture below. Use your finger to prevent the nut from falling out. **This might take a couple of tries to get it right.**

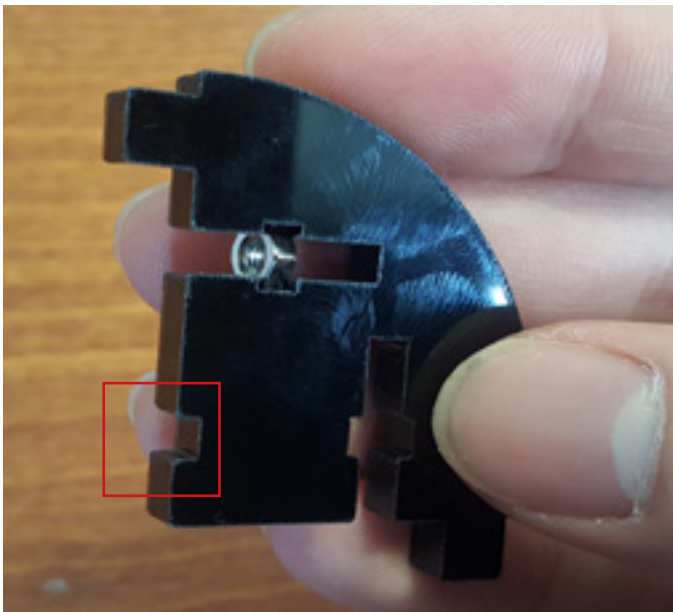

2) Fit together 'Acrylic Piece 2' as shown below.

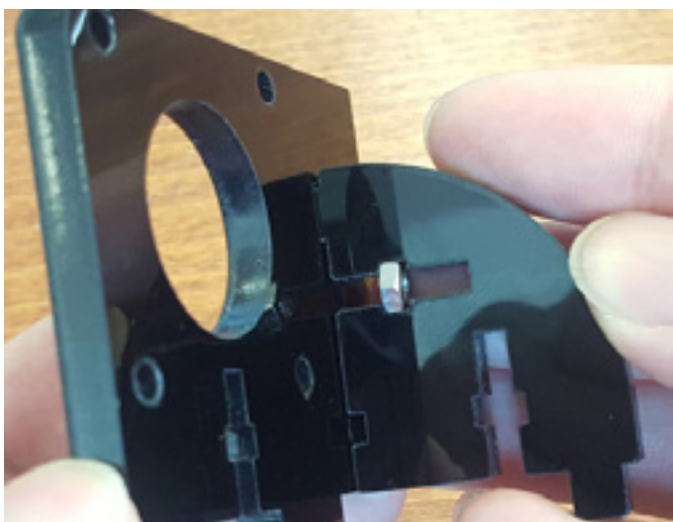

3) Insert the M3 20mm Screw in the hole on the acrylic as shown in the picture below. Tighten the screw with a screwdriver. **Please note that this process will be repeated many times throughout the guide.**

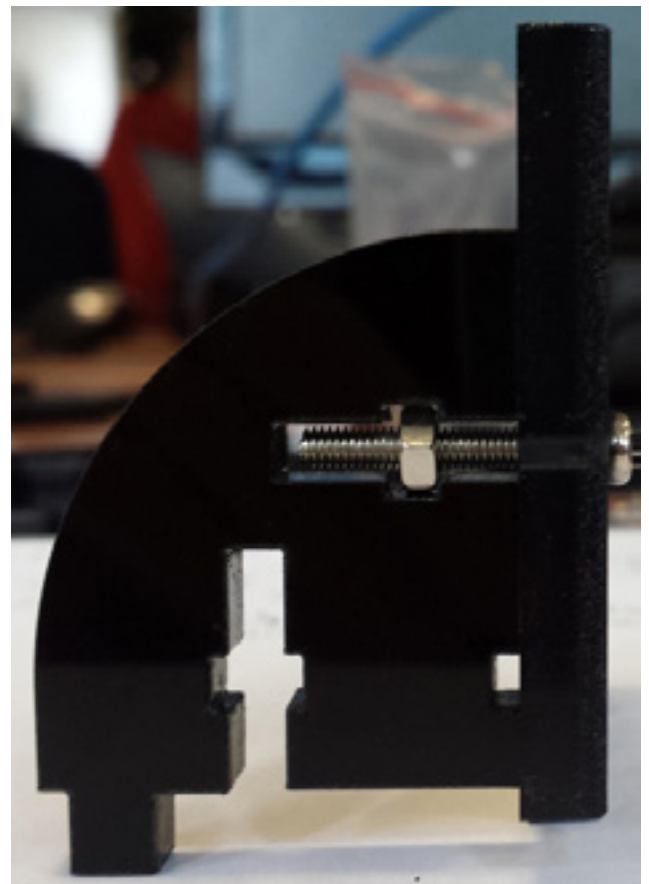





4) Tighten M3 10mm Screw x4 to secure the stepper motor to the Assembled Acrylic Piece. **Please note the orientation of the white socket on the stepper motor.**



Step 2: Assemble Y-Limit Switch (2 - 6 mins)

Parts Required

			
Acrylic Piece 3	Limit Switch	M2 Nut x2	M2 20mm Screw x2

1) Fit 'Acrylic Piece 3' to the Limit Switch and insert M2 Screw x2 into the holes. **Note the orientation of ther acrylic piece.**



2) Secure it tightly with the M2 Nuts x2.



Step 3: Install Rod Caps (4 mins)





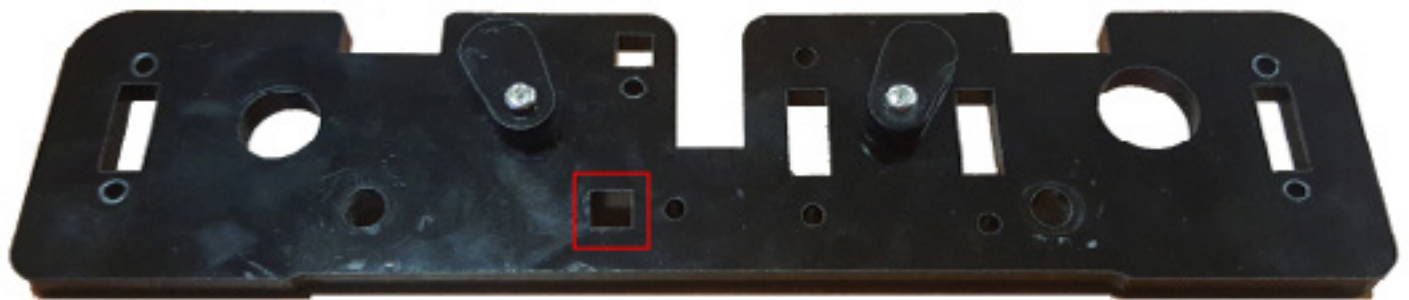

Parts Required			
			
Back Base Frame	Rod Cap x2	M3 Nut x2	M3 20mm Screw x2

1) Attach the rod caps to the 'Back Base Frame', secure it with a M3 Screw and M3 Nut at the back. The rod caps are to cover the two holes above the screw gap.

Take notice of the orientation of the 'Back Base Frame' by referencing the hole highlighted.



Step 4: Assemble Back Base Frame (6 - 10 mins)

Parts Required			
			
Motor Holder	Assembled Y-Limit Switch from Step 2	Assembled Y-Axis Motor From Step 1	Assembled Back Base from Step 3
			
M3 Nut x5	M3 20mm Screw x5		

1) Fit the Motor Holder to the Assembled Back Base with the same screwing process as Step 1. Secure using one M3 Nut and one M3 20mm Screw.

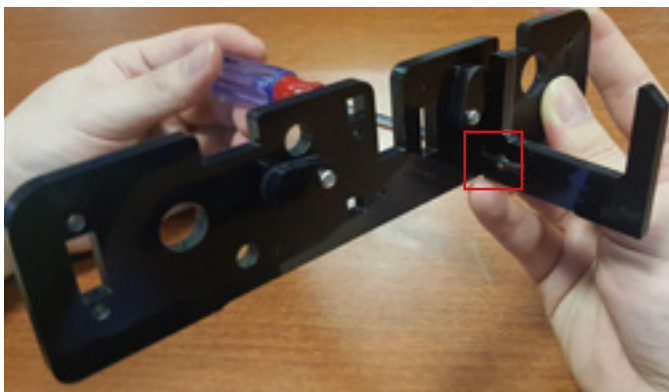

2) Attach Assembled Y-Axis Motor to the frame. **Pay attention to the orientation.** Secure the Assembled Motor further by using M3 Nut x3 and M3 20mm x3 to the hole highlighted.

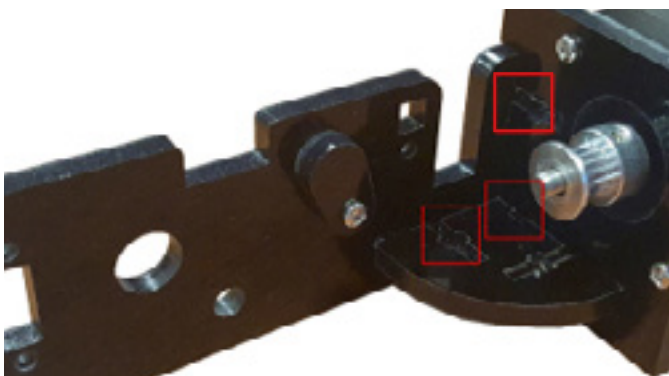

3) Attach the Assembled Y-Limit Switch to the frame, secure it with one M3 20mm Screw and one M3 Nut with the same screwing process as STEP 1. **Make sure all highlighted areas are secured.**

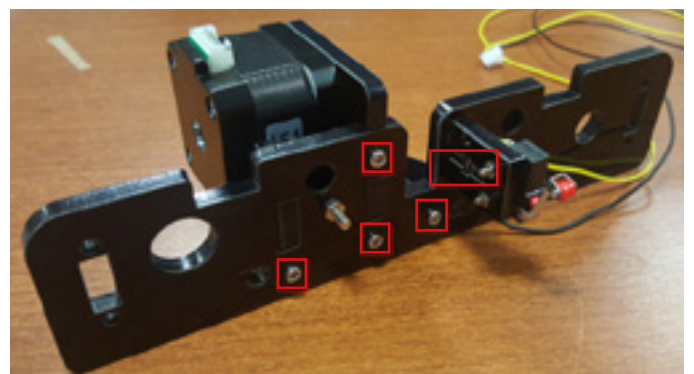
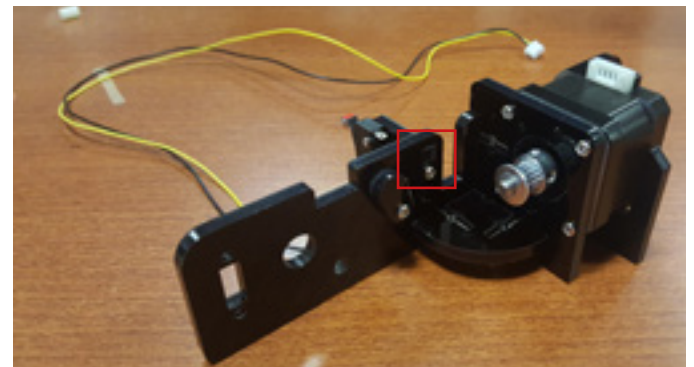

Step 5: Assemble Y-Axis Idler (4 - 8 mins)

Parts Required			
			
			M3 20mm Screw x4
			
Acrylic Piece 4	Idler	Rod Cap x2	M3 Nut x4



1) Attach the Idler to 'Acrylic Piece 4'. Secure with M3 20mm Screw x2 and M3 Nut x2.



2) Attach the Rod Caps x2 with M3 20mm Screw x2 and M2 Nut x2 in the areas shown.



Step 6: Assemble Y-Carriage (6 - 10 mins)

Parts Required		
		
		M4 10mm Screw x9
		
Acrylic Piece 5	Linear Bearings x3	Smooth Rod x2

1) Attach the Linear Bearings to 'Acrylic Piece 5'.
Loosely tighten them up with M4 Screw x9. The Linear Bearings should be loose enough to move slightly, but still remain attached.



2) Insert the Smooth Rods into the bearings. These are the **shortest and thickest** smooth rods.







3) Move the rods forward and back several times to ensure the oil in the bearing is evenly distributed.

4) Now you may tighten the screws on the bearing.



Step 7: Assemble Z-Axis Motors (6 - 10 mins)

Parts Required			
			
Acrylic Piece 6 x2			
			
M3 10mm Screw x8	Stepper Motor with Coupler x2	Wire 'Z1' (Short)	Wire 'Z2' (Long)

1) Make sure the coupler has some clearance to the base of the shaft on the stepper motor.

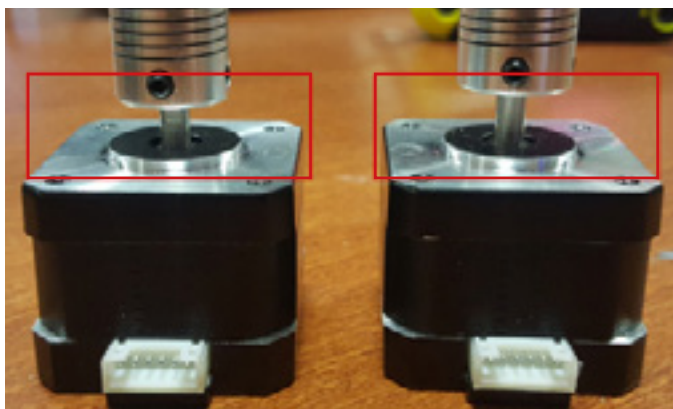

2) Place 'Acrylic Piece 6' on top of the Stepper Motor with Coupler. Do this for both motors. **Pay attention to the orientation of the larger hole on 'Acrylic Piece 6'. One hole should be on the left and another on the right.** Secure with M3 10mm Screw x8.

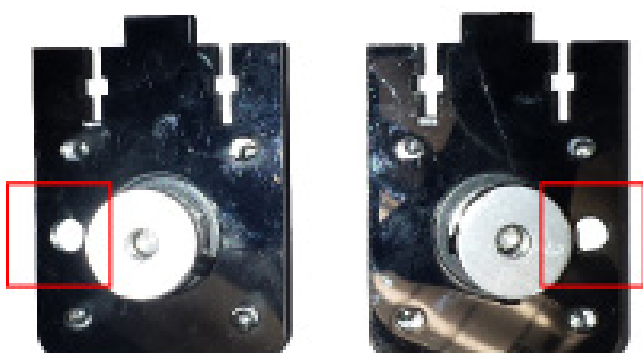

Left Stepper Motor

Right Stepper Motor



3) Attach the wires to the Stepper motors, Wire Z1 (short) is for the Left stepper motor and Wire Z2 (long) is for the Right stepper motor. **Please label the wires if it hasn't been labelled yet.**

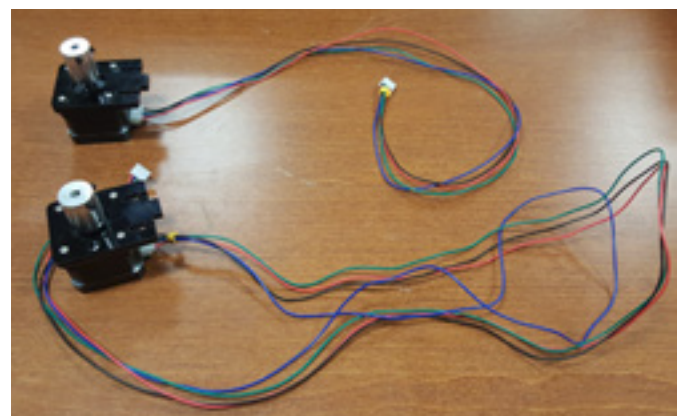

Step 8: Assemble Front Bottom Plate (4 - 10 mins)

Parts Required			
			
Assembled Left Stepper Motor from Step 7	Assembled Right Stepper Motor from Step 7	Acrylic Piece 7	M3 Nut x4
			
			M3 20mm Screw x4

1) Put the wires through 'Acrylic Piece 7'. Left Stepper Motor on the left and Right Stepper Motor on the right.

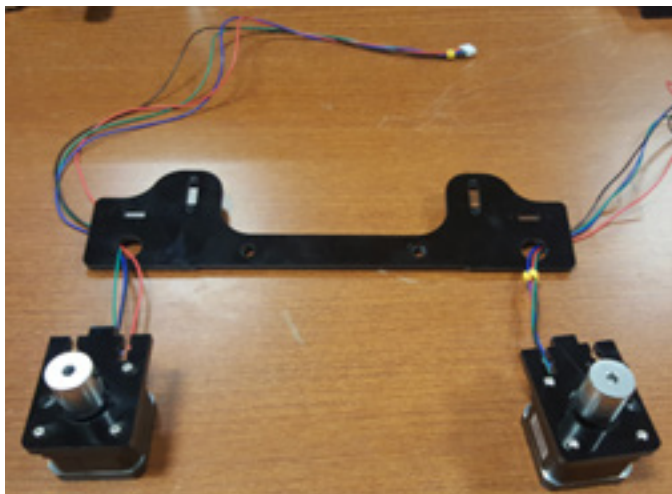





2) Fit the two Assembled Stepper Motors with 'Acrylic Piece 7' and secure with M3 Nut x2 and M3 20mm Screw x2 with the same screwing process as Step 1.

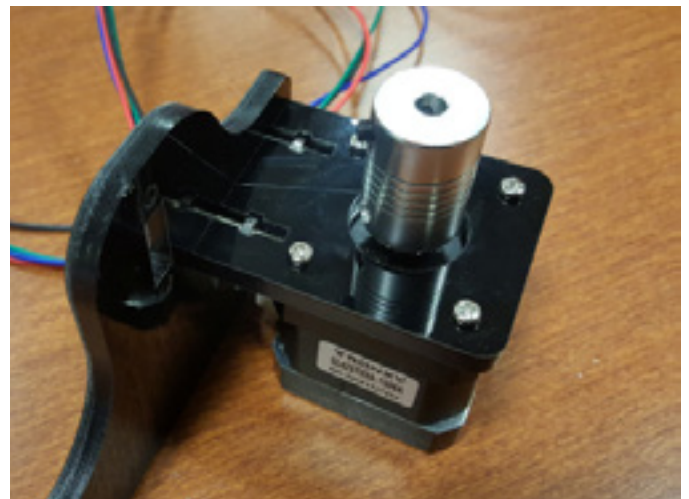

3.) Repeat on the other side.





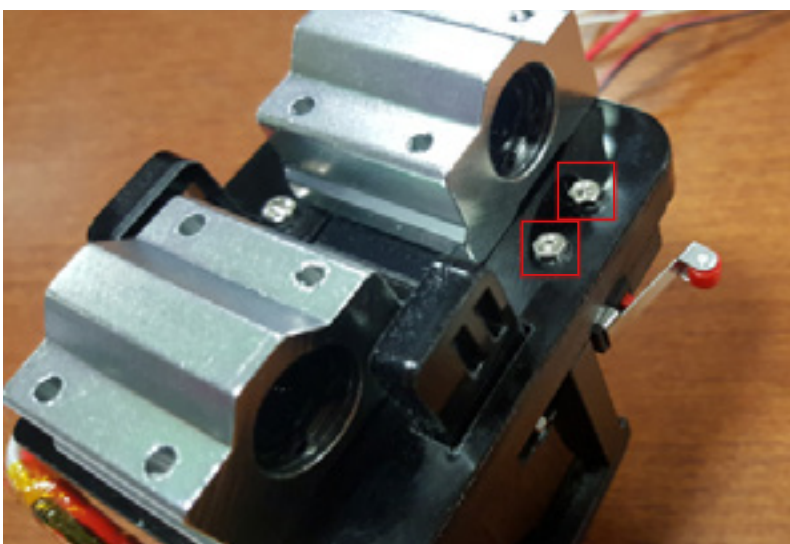

Step 9: Assemble X-Limit Switch (2 - 3 mins)

Parts Required		
		
Limit Switch	Hot End	M2 Nut x2
		
		M2 20mm Screw x2

1) Attach the Limit Switch (not the assembled one) to the Hot End. Secure it with M2 Screw x2 and M2 Nut x2.



Step 10: Assemble Side Plates (6 - 10 mins)





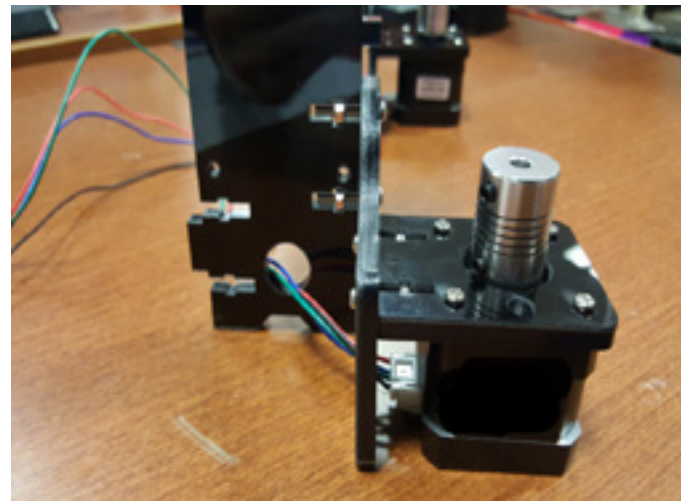

Parts Required		
		
		M3 Nut x4
		
		M3 20mm Screw x4

1) Attach Side Plate x1 to the Assembled Front Bottom Plate. Secure it with M3 Nut x2 and M3 20mm Screw x2. **Pay attention to the orientation of the Side Plate to the Assembled Front Bottom Plate. The *flat edge* of the Side Plate should be attached to the body.** Repeat on the other side.

2) Pierce the wires through the holes of the Side Plates - **inwards**.



Step 11: Install Z-Limit Switch (6 - 10 mins)

Parts Required			
			
Assembled Front Bottom Plate from Step 10		Limit Switch	Acrylic Piece 8
			
M3 Nut x1	M3 20mm Screw x1	M2 Nut x2	M2 20mm Screw x2

1) Locate the M2 20mm screws from the bag with small acrylic parts.







2) Attach the Limit Switch to the highest point of the elliptical gap on 'Acrylic Piece 8'. Secure with M2 Screw x2 and M2 Nut x2.

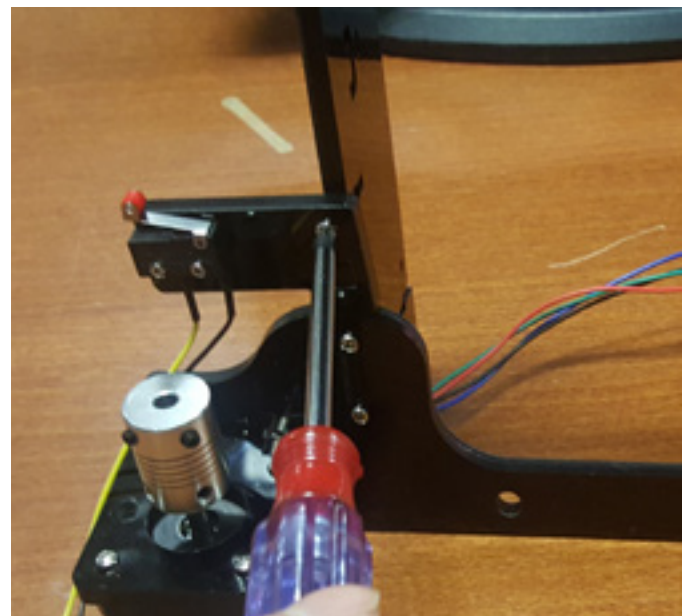

3) Fix the assembled Limit Switch onto the Assembled Front Bottom Plate using M3 20mm Screw x1 and M3 Nut x1.

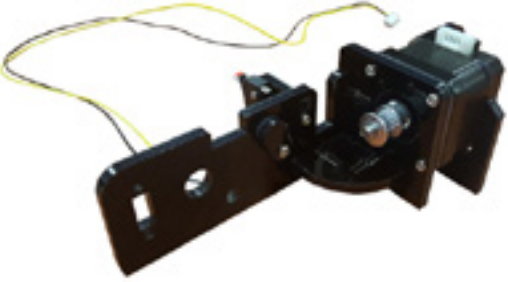

Step 12: Assemble the Body (8 - 12 mins)

Parts Required		
		
		M3 Nut x4
		
Assembled Back Base Frame from Step 4	Assembled Front Bottom Plate from Step 11	M3 20mm Screw x4

1) Fit the 'Assembled Back Base Frame' to the 'Side Plates' of the Assembled Front Bottom Plate as shown below. Secure with M3 20mm Screw x2 and M3 Nut x2 with the same screwing process as Step 1. Repeat on the other side.

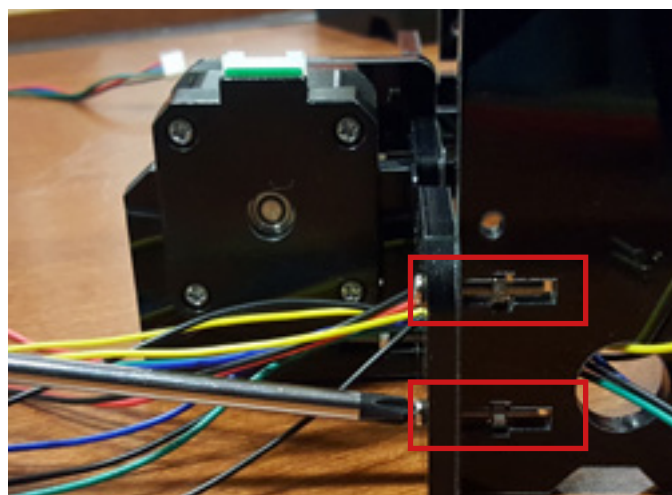
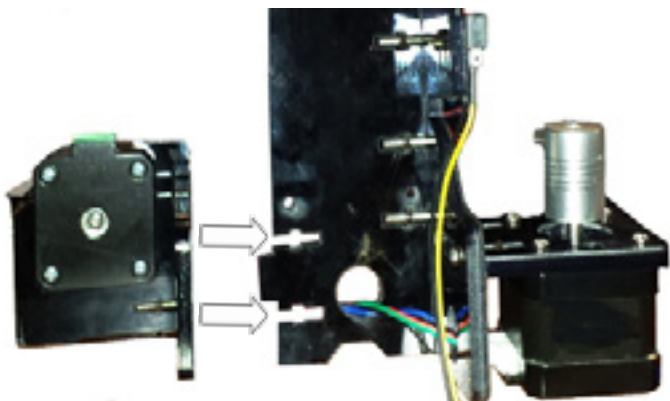

2) To tidy up the wires a bit more, pierce all the wires attached through the appropriate Side Plates and through to the Assembled Front Bottom Frame through the hole on the left side of the Assembled Back Base Frame. All wires should gather to the same hole. The yellow and black wire from Step 11 is optional.

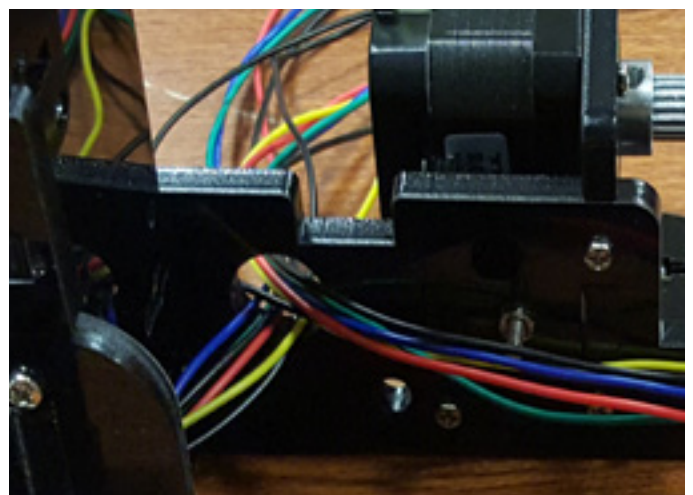
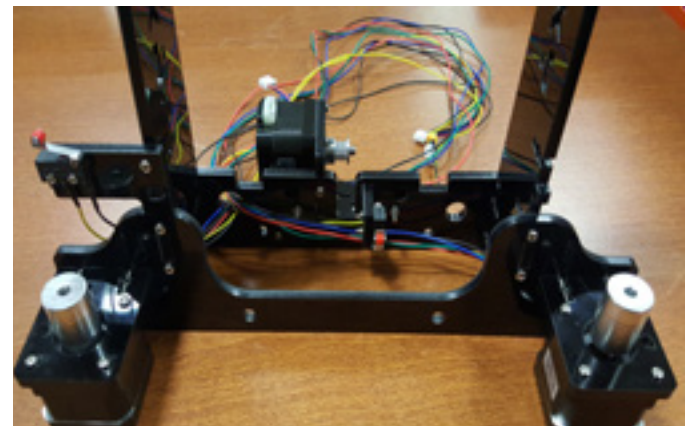

Step 13: Installing DC Power Jack (2 - 4 mins)

Parts Required

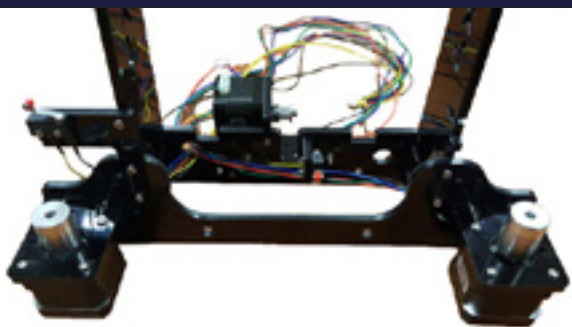
	
<p>DC Power Jack</p>	<p>Assembled Body from Step 12</p>

1) Remove the metal ring completely by rotating it out.



2) Insert the Power Jack into the hole of the Assembled Body and secure its position by affixing the ring back on.

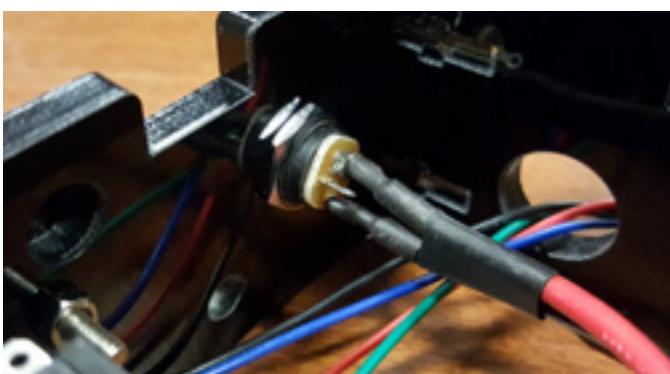
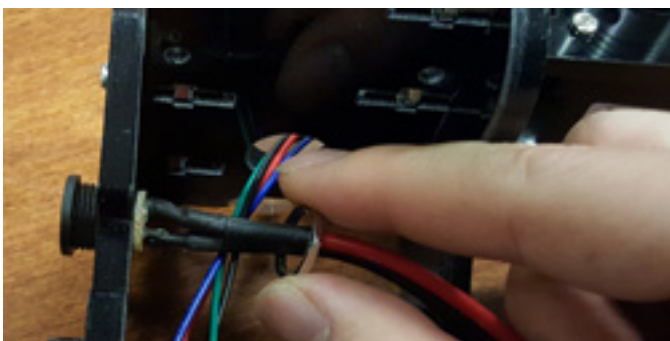

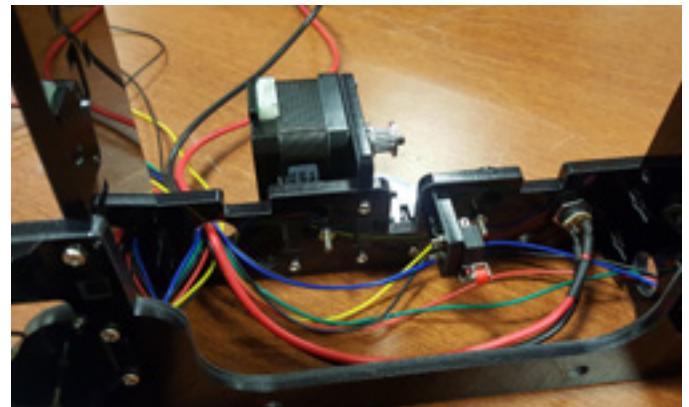

3) Tidy up the wires by passing the wires through the same hole as the others.



Step 14: Threaded Rod Install (10 - 16 mins)

Parts Required

	
Threaded Rod x2	M5 Nut x10

1) This step requires two Threaded Rods (top), not to confuse with Lead Screw (bottom). The difference between the two is the track thickness. The ones we are using for this step are the rods that have a thinner and sharper track.

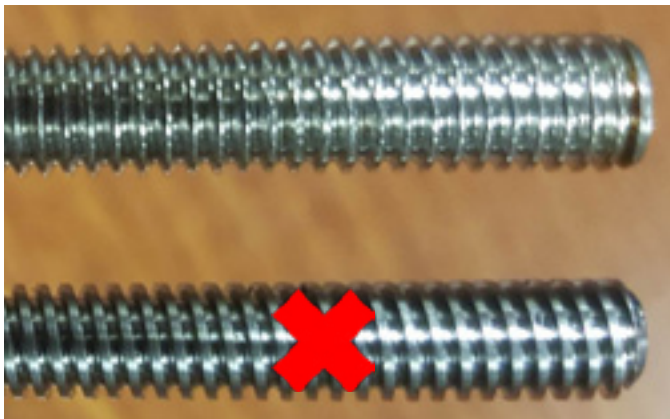

2) Insert the Threaded Rod through the front base plate and secure with M5 Nut x4 to both surfaces of the acrylic plastic making sure that the nuts are tightly on.

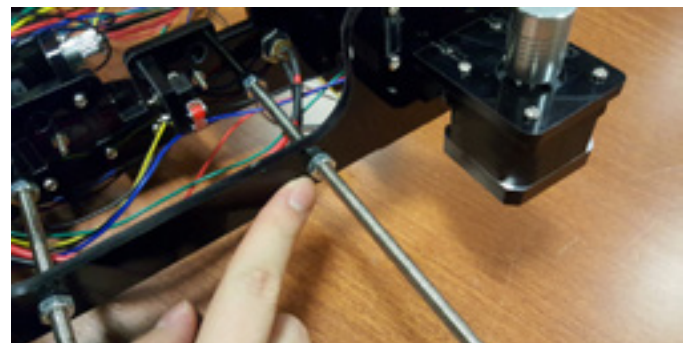
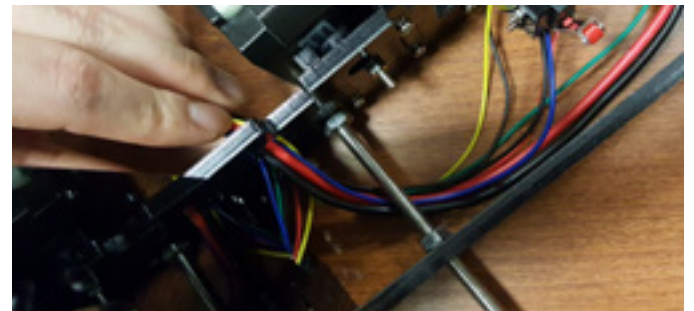

3) Insert one more M5 nut to each of the threaded rods on the long end.

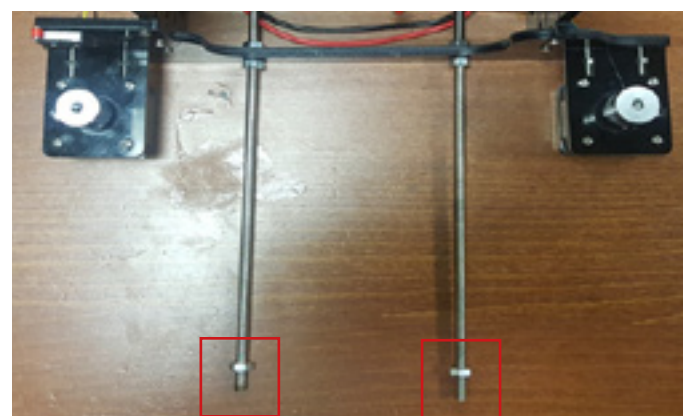

Step 15: Install Y-Carriage to Body (2 - 4 mins)

Parts Required

		
Assembled Y-Carriage from Step 6	Idler from Step 5	M5 Nut x2

1) Flip the Assembled Y-Carriage so that it is upside down and insert the rods into the back frame, the smooth rods to meet the rod caps on the back frame. The wider side should be on the left and the thinner side on the right.

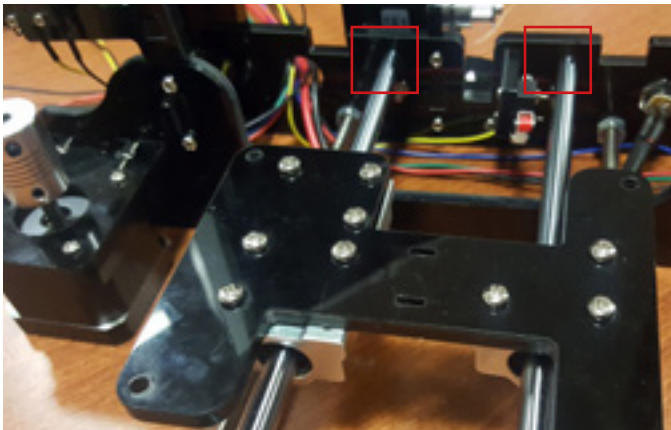

2) Insert the Y-axis idler, the smooth rods should meet the other side of the rod caps on the idler.

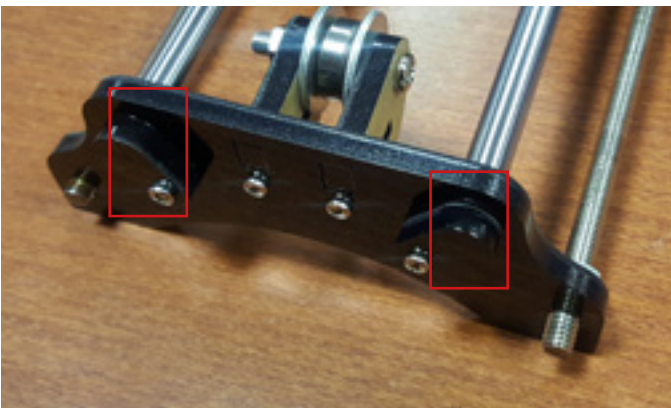

3) Insert M5 Nut x2 at the front to secure the idler.

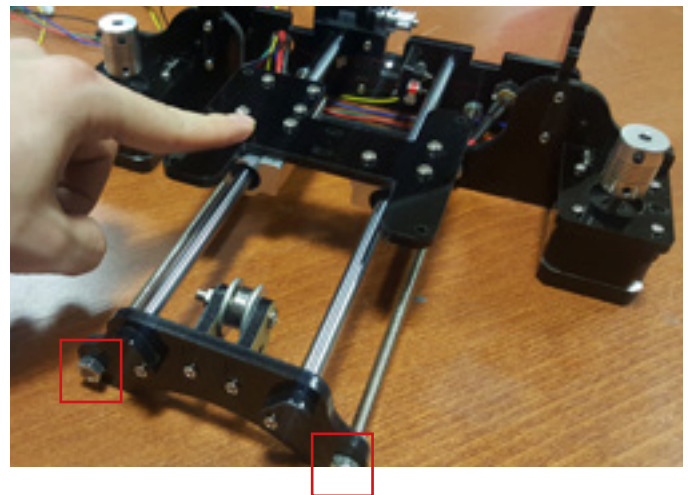

4.) You may use the 3D printed spanner included in the box to secure all the nuts.

Step 16: Install Y-axis belt (6 - 10 mins)

Parts Required



Zip Tie x2



Belt

1) Insert the belt into the Idler. Smooth side on the outside.

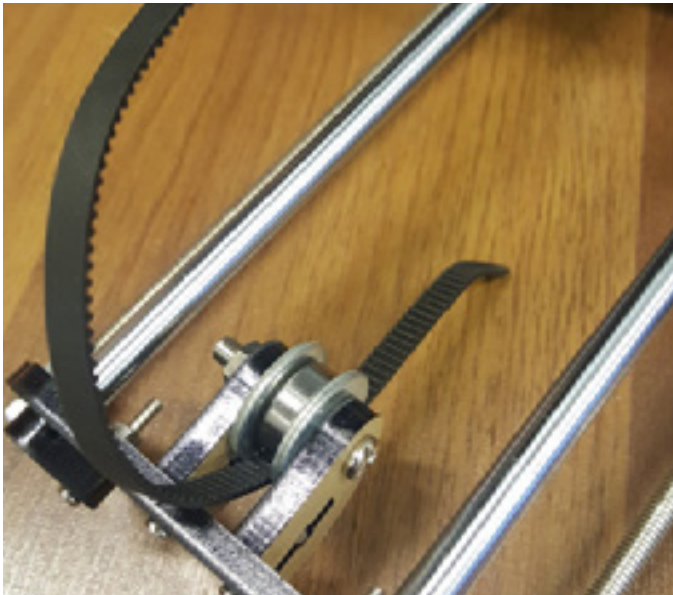

2) Pull the belt through underneath the Y-Carriage until it meets with the Stepper Motor.

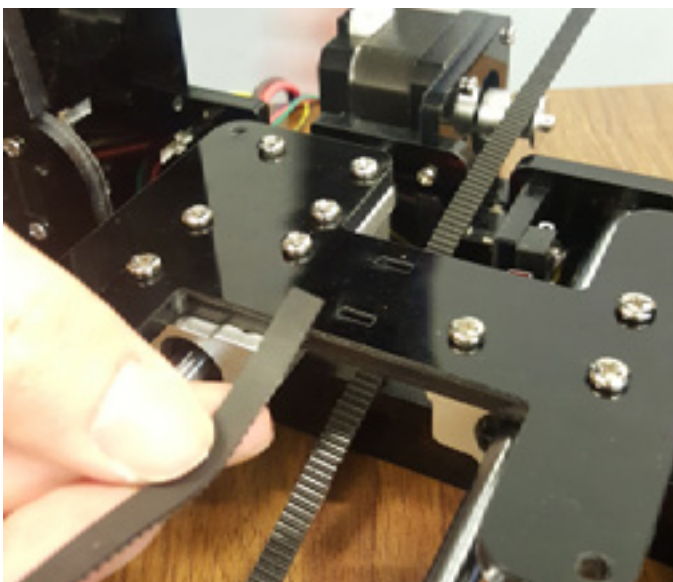

3) Slot the end of the belt closest to the Idler into the slot shown on the Y-Carriage.

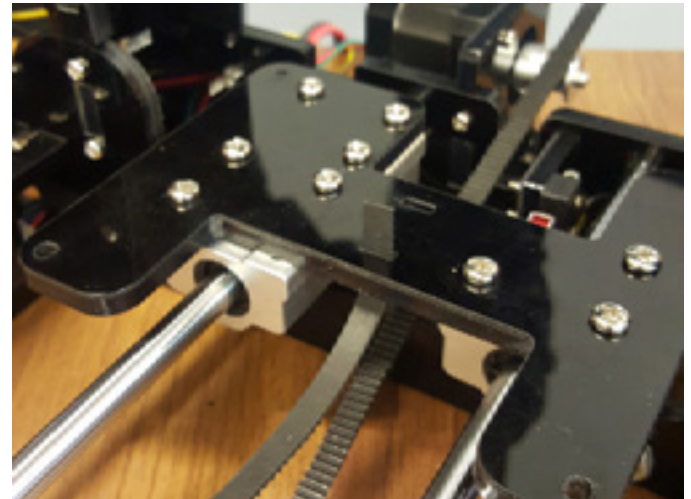

4) Use one Zip Tie to tie up the open end of the belt inside the Y-Carriage. To use the zip tie, loop the end through the opening on the other side until it is of similar diameter of your index finger. Place the loop over the end of the belt which you wish to secure and pull the tail **tightly**.

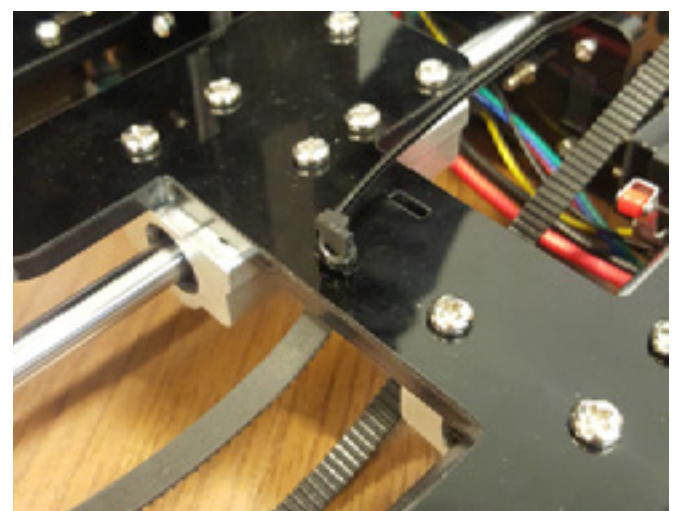

5) Using the appropriate allen key, untighten the screw on the Stepper Motor.

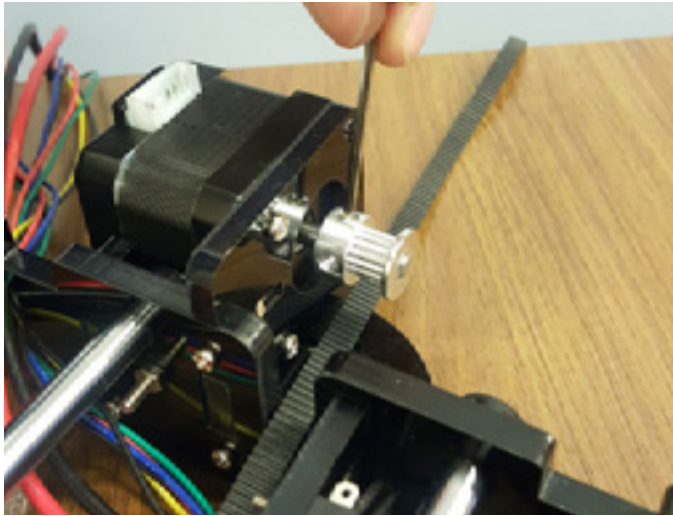

6) Wrap the belt back over the Stepper Motor to meet with the slot of the Y-Carriage and place it in. Make sure the belt is very tense before securing the zip-tie.

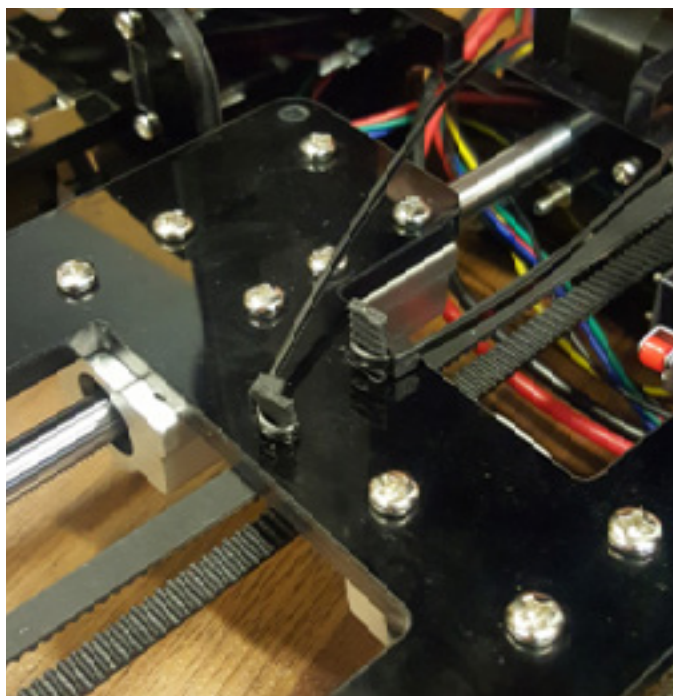
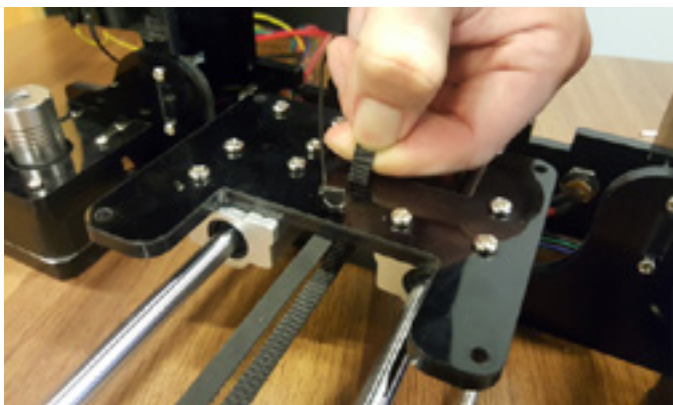

7) Align the belt until it is straight by adjusting the untighten Stepper Motor nib.

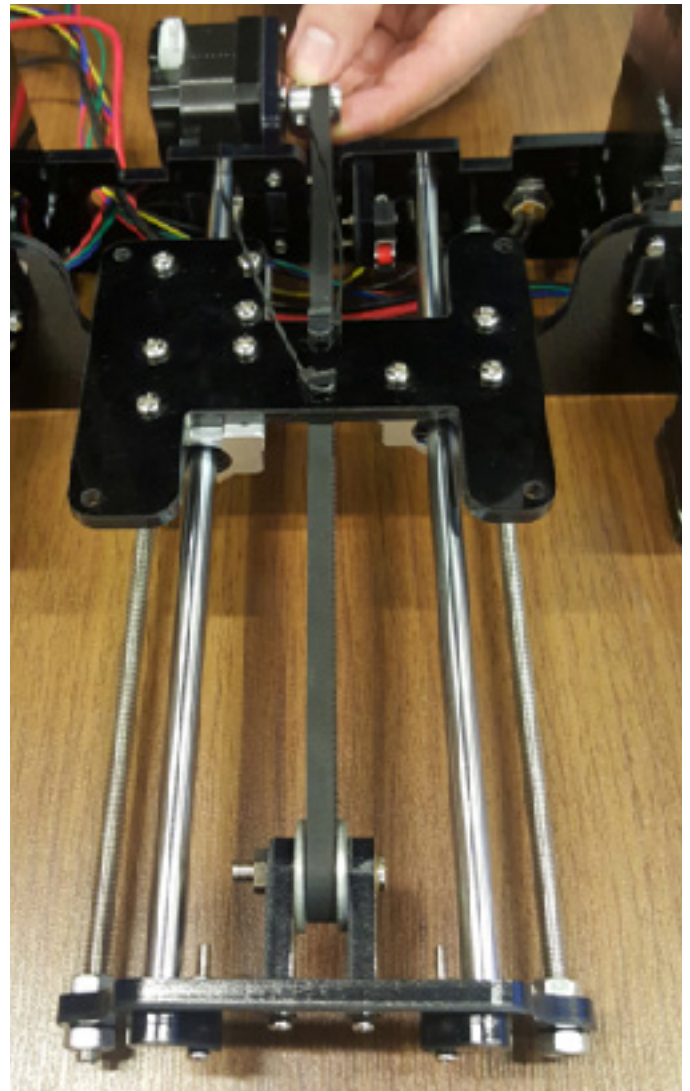



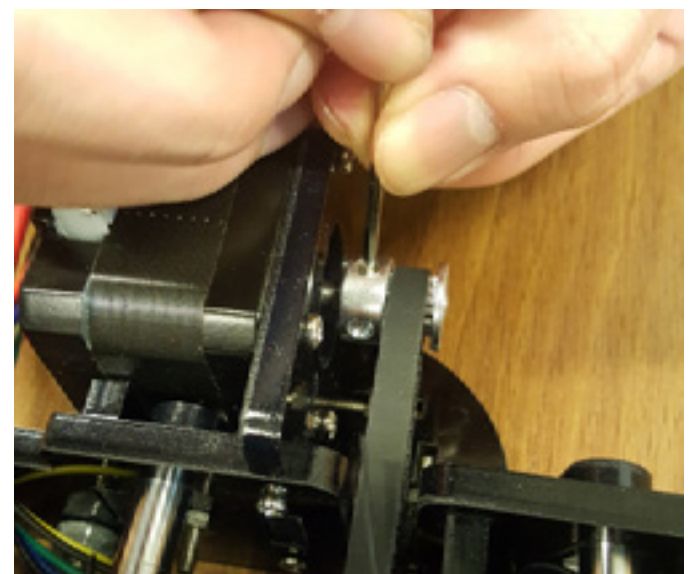

8) Tighten the Stepper Motor when you have got the right positioning.

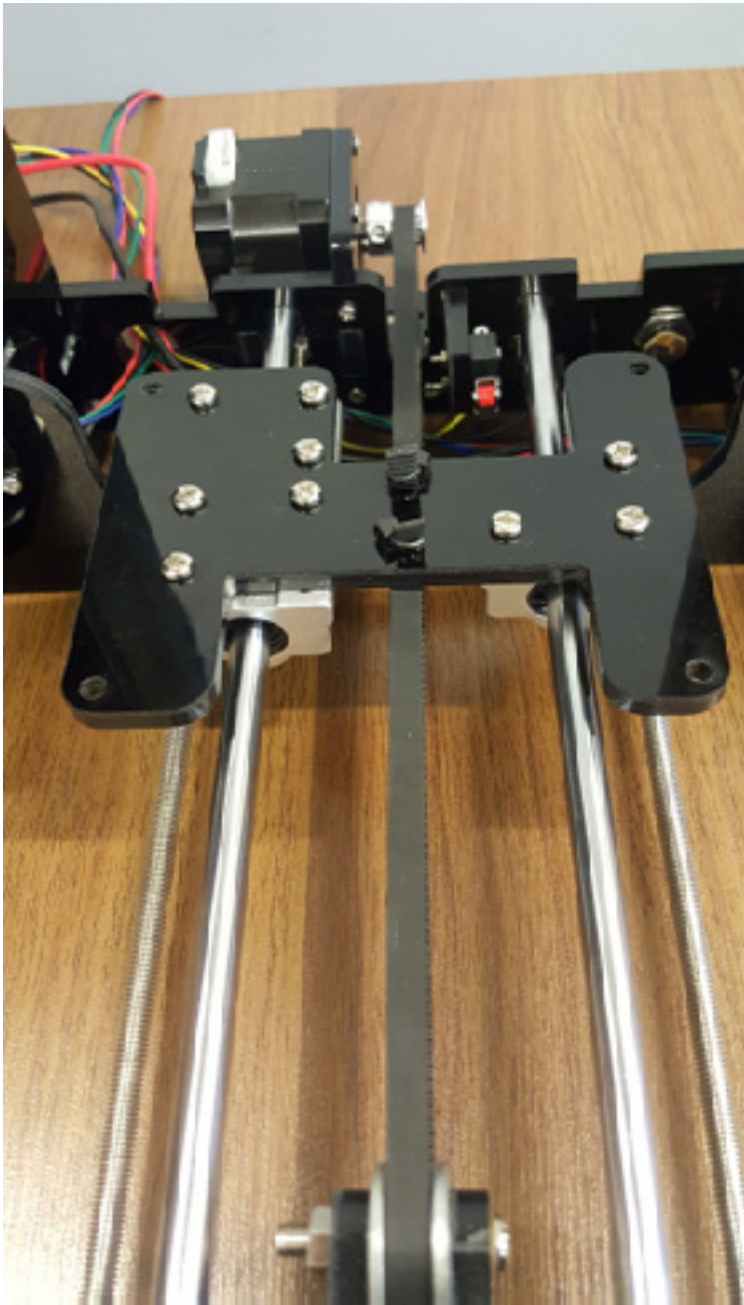

9) Cut the excess from the zip ties.



Step 17: Top & Junction Plate (8 - 10 mins)

Parts Required			
			
Junction Plate x2	Rod Cap x2	Screen Plate	M3 Nut x10
			
			M3 20mm Screw x10

1) Attach a Rod Cap to the Junction Plate, secure it with a M3 20mm Screw x1 and M3 Nut x1 making sure to cover the hole.



2) Repeat the process with the other junction plate. **Pay attention to the orientation of the junction plate.**



3) Attach the Screen Plate to the Side Plate. **Pay attention to the orientation of the Screen Plate.**

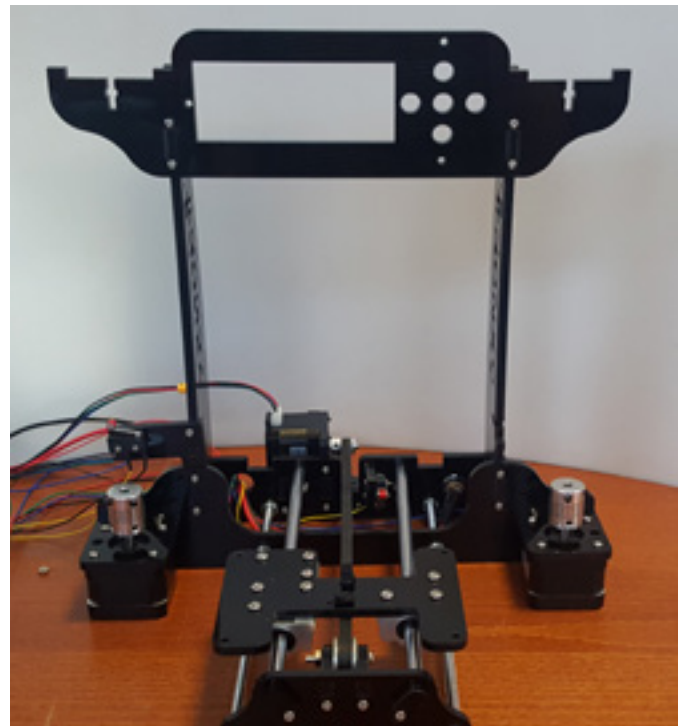



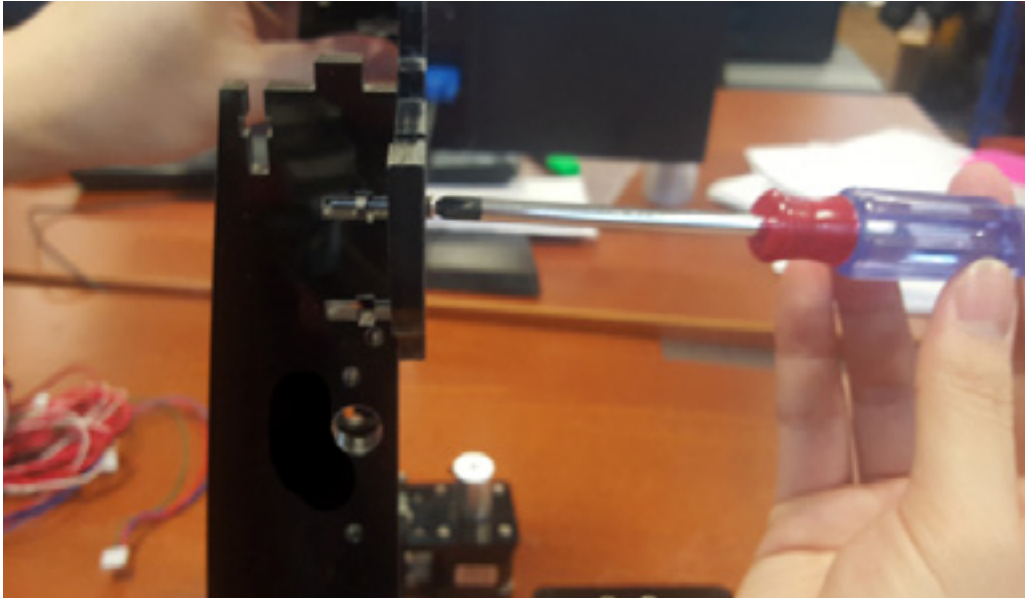

4) Secure the screen plate using the M3 20mm Screw x2 and M3 Nut x2 using the same screwing process as Step 1. Repeat on the other side.

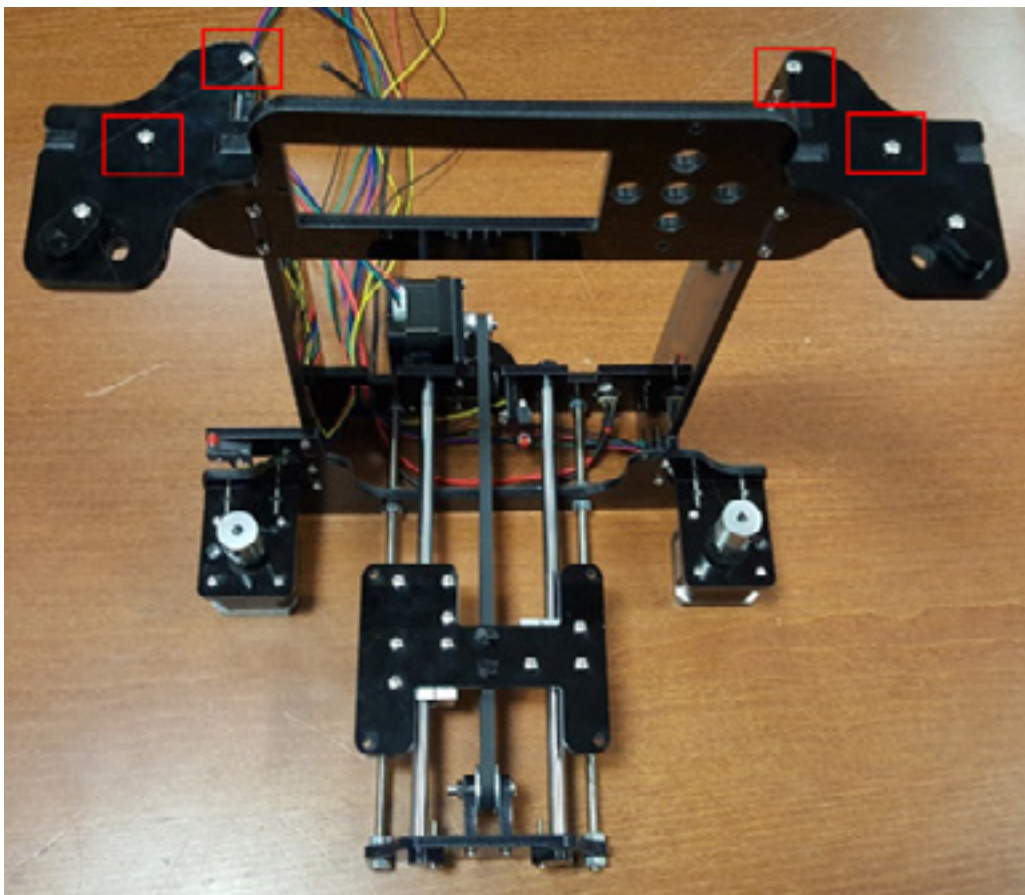

5) Attach the junction plates on top of the side plates, secure them with M3 20mm Screw x4 and M3 Nut x4. **Attention to the orientation of the junction plate.**



Step 18: X-Motor Assembly (2 - 4 mins)

Parts Required			
			
Stepper Motor With Pulley	Left X-axis idler	'X' Wire (Short)	M3 10 mm Screw x3





1) Secure the Stepper Motor to the idler part using M3 8mm Screw x3. **Pay attention to the orientation of the Stepper Motor.**

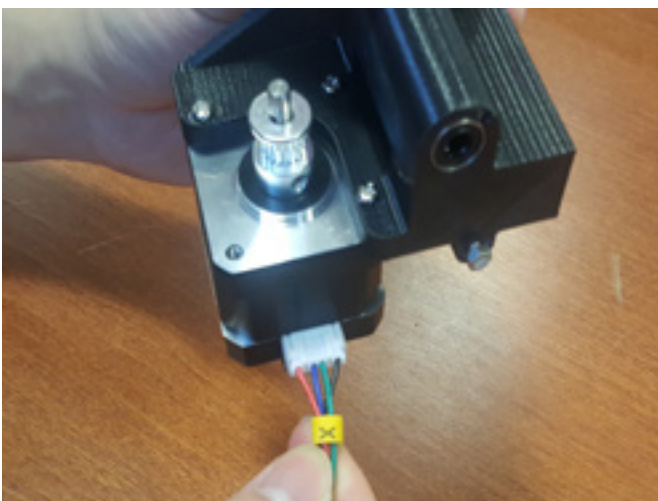

2) Attach the 'X' Motor Wire (Short) to the Stepper Motor. **Please label the wires if it hasn't been labelled yet.**

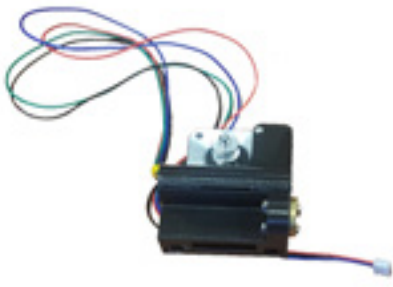

Step 19: X-Axis Assembly (4 - 8 mins)

Parts Required		
		
Assembled X-Motor from Step 18	Right X-axis idler	
		
28.5cm Smooth Rod x2		Assembled Hot End from Step 9

1) Insert the Smooth Rods (these should be the thicker ones) into the holes on the Assembled X-motor and push it all the way in until it's secured. If the rods are difficult to slide into the holes of the 3D printed parts, try filing wider the holes.



2) Slide the Smooth Rods into the Hot End.

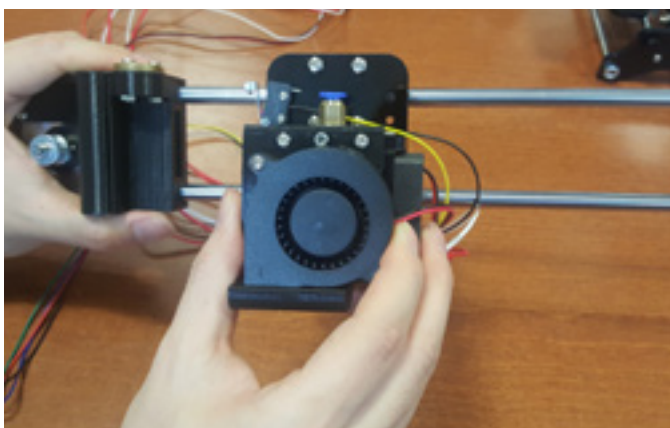

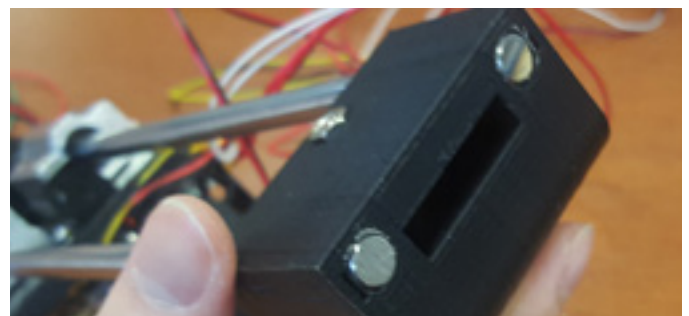
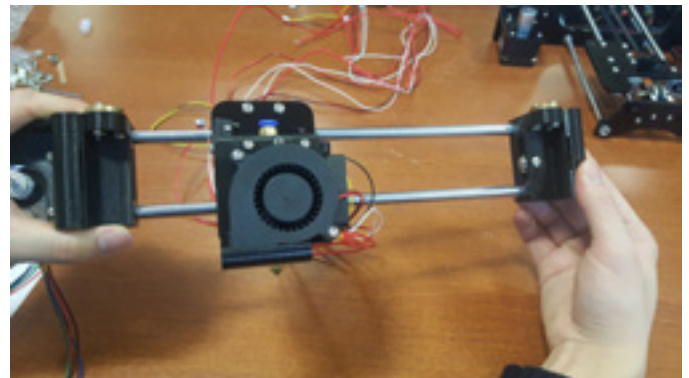

3) Insert the 3D Printed Part to the smooth rods. **Use some force if necessary.**

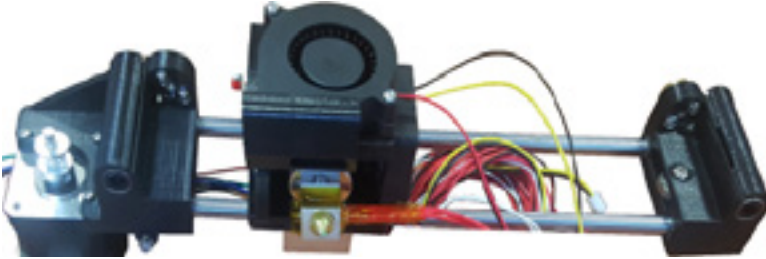

Step 20: Attach X-Axis to Body (15 - 20 mins)

Parts Required

	
<p>Assembled X-Axis from Step 19</p>	<p>M6 Smooth Rod x2</p>
	
	<p>M5 Lead Screw x2</p>

1) Open up the Rod Cap on the Junction Plate.

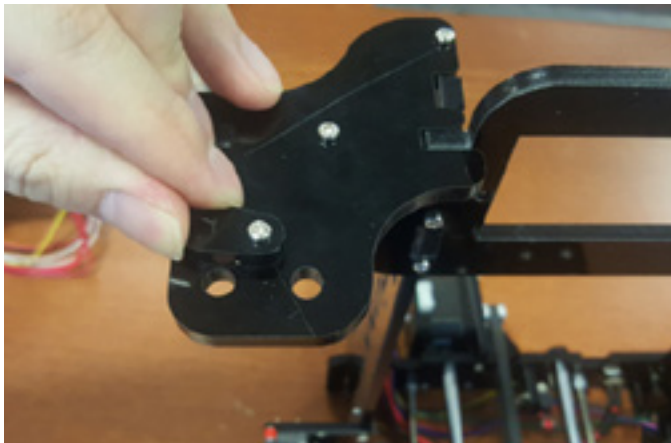

2) Slide in the Smooth Rod through the Junction Plate and the 3D Printed Part and to the hole on the acrylic plate on the Stepper Motor and close the Rod Cap. Repeat on the other side.

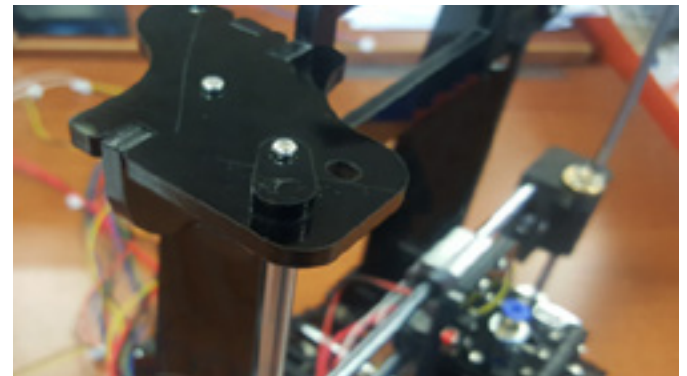
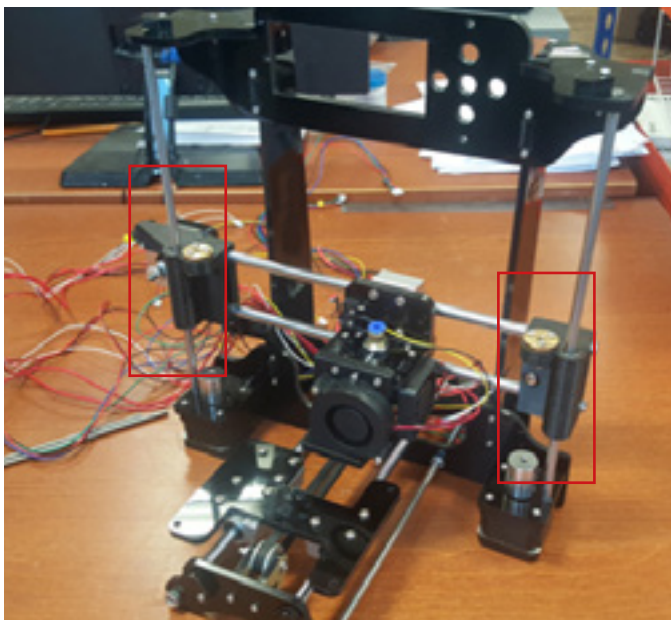

3) Slide the Lead screw through the Junction Plate and twist it into bronze metal part on the X-Axis. Have the Lead Screw meet the Coupler on the Stepping Motor. Adjust the coupler so that the shaft of the motor and Lead Screw is inside the coupler and the Threaded Rod is not leaving the Junction Plate. Repeat on the other side. **Both the Lead Screw and the motor shaft should meet the set screws in the coupler.**

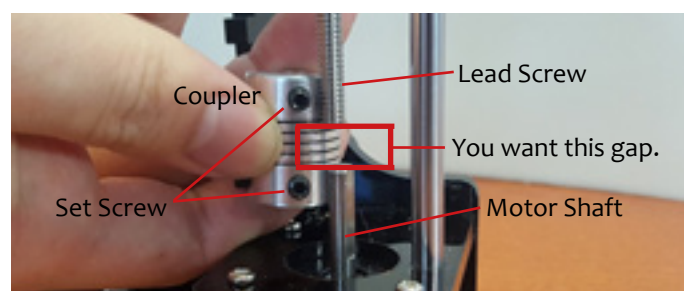
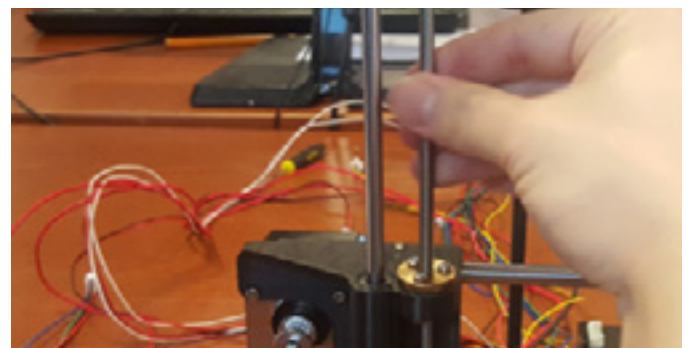

- 4) Secure all the set screws on the coupler with the suitable allen key.
Repeat the same process on the other side.

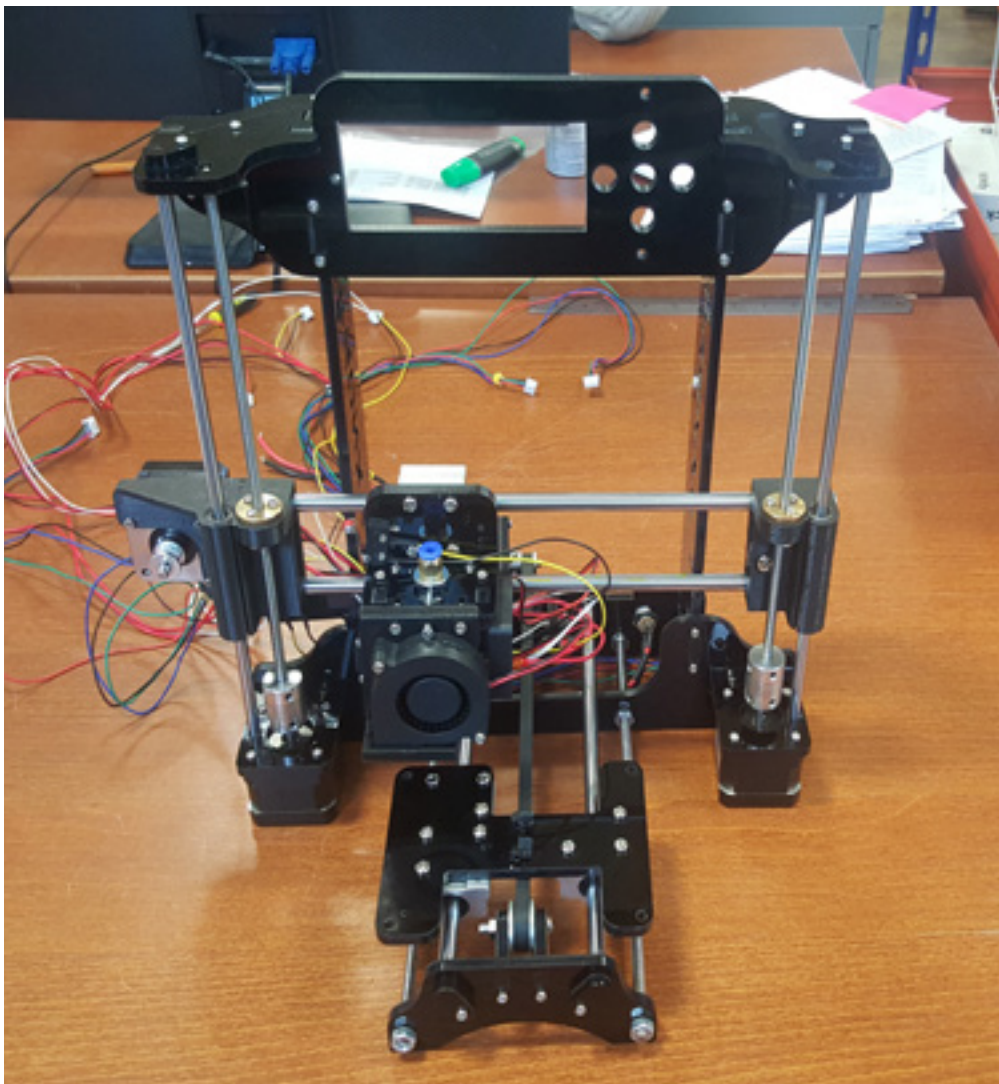
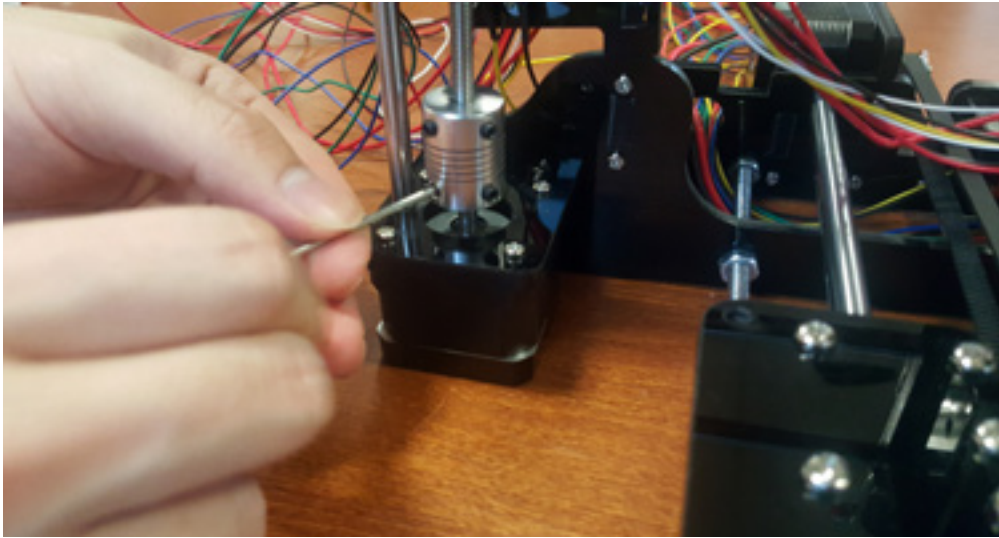

Step 21: X-Axis Belt (5 - 7 mins)

Parts Required



Zip Tie x2



Belt

1) Insert the belt (smooth side out) from the side and feed it through the acrylic piece to meet the back of the Hot End. Place it through the acrylic piece at the back of the Hot End. You'll notice there is an area that is a space for the belt go through. Pierce this through and then back out again.

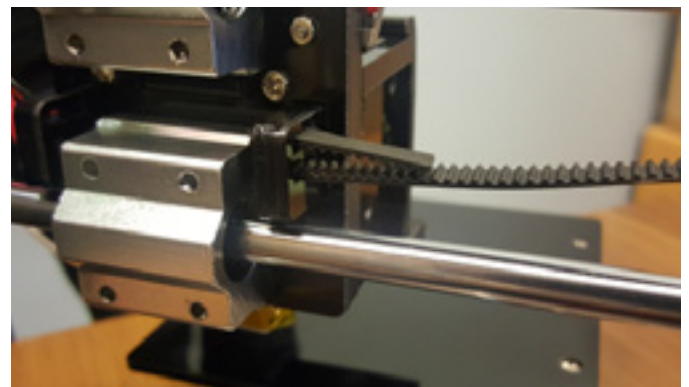
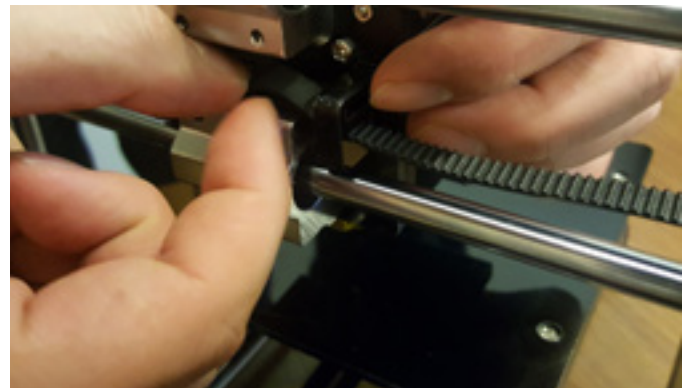
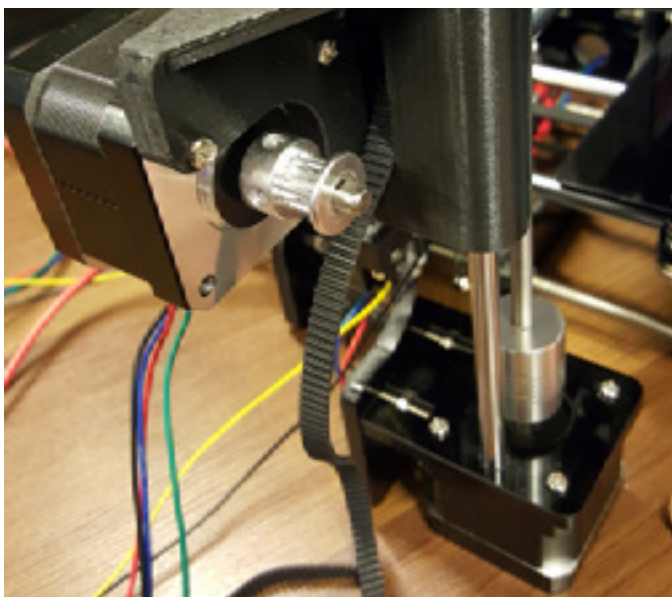

2) Secure the end by using a zip tie.

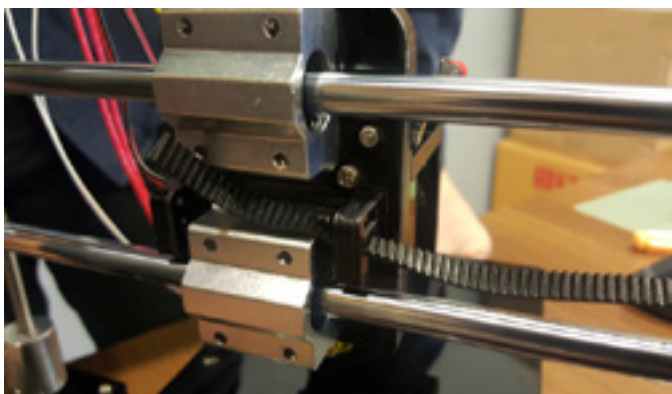

3) Using the other end of the belt, feed it back over the Stepper Motor and through the acrylic piece.

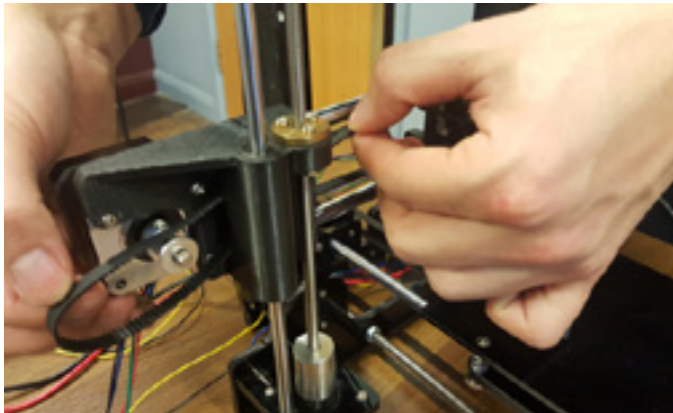

4) Keep the belt positioned between the gap of the Linear Bearings and place it through the other piece of acrylic on the other side. Go through the upper gap.

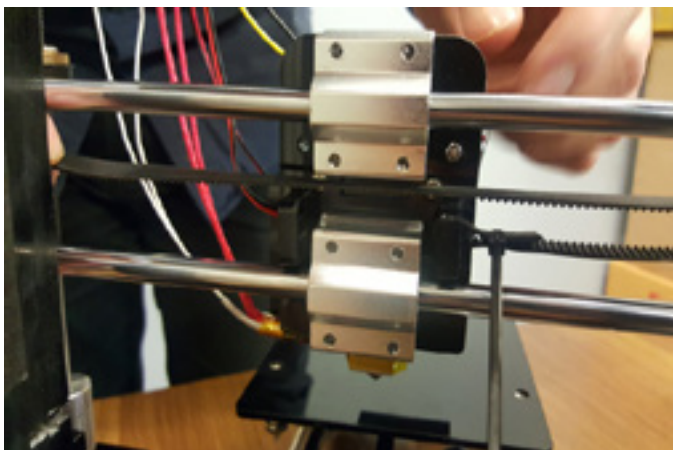

5) Feed it back around through the bottom gap of the acrylic piece.

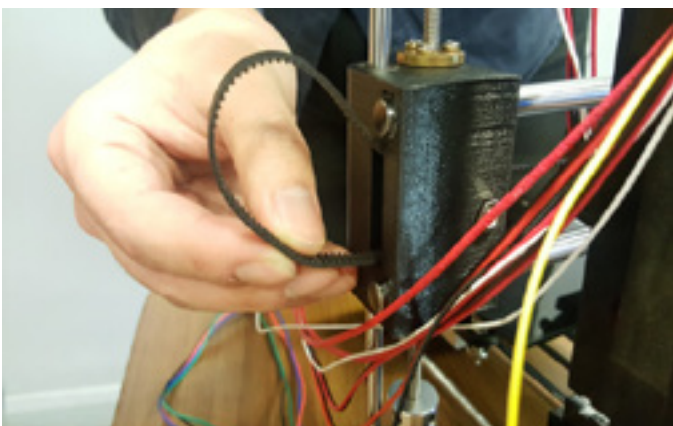

6) Fit it through the other bottom slot of the Hot End.

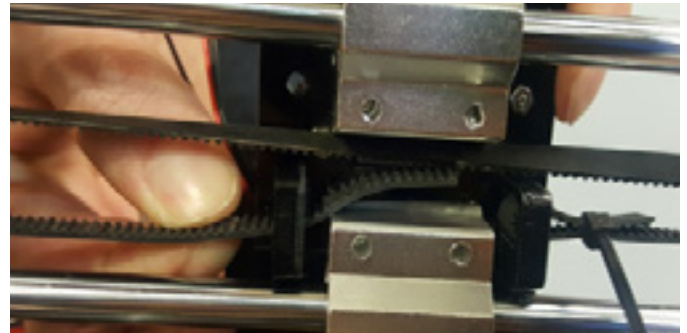

7) Put it through the slot above it.

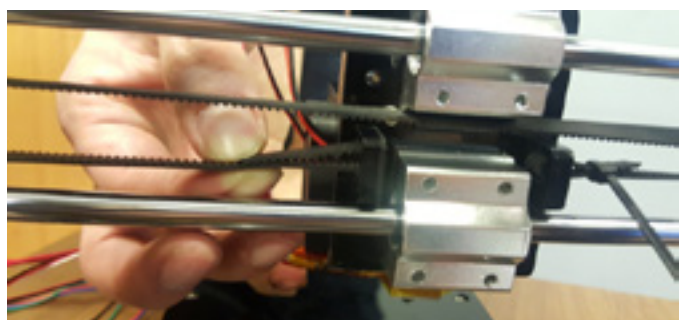

8) Make sure the belt is **very tight** and then secure it using a zip tie.

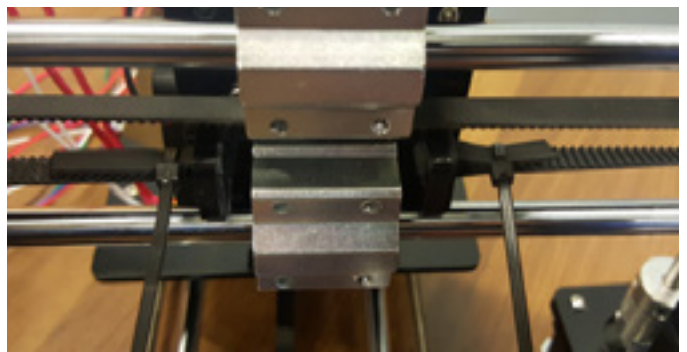

9) Cut the excess off.

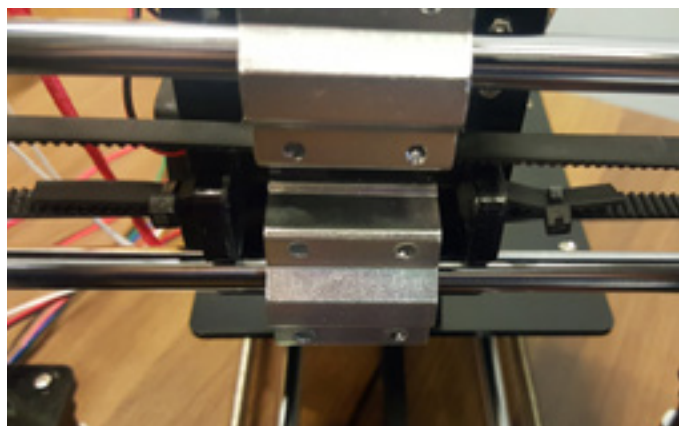

Step 22: Install LCD screen (2 - 4 mins)

Parts Required





	
	M3 Nut x3
	
LCD Screen	M3 25mm Screw x3

- 1) Fit together the LCD screen and the Screen Plate.
Secure the screen using M3 25mm Screws x3 and M3 Nuts x3.



Step 23: Install Extruder (2 - 4 mins)

Parts Required

			
Teflon Tube	Extruder Motor	'E' Motor Wire	M3 10mm Screw x2

1) Insert the Teflon Tube on the right side plate. Twist the metal part of the tub to the extruder motor as shown in the picture. **Pay attention to the orientation of the Extruder Motor. If your extruder doesn't have wire attached please attach a long wire to it and label it "C"**

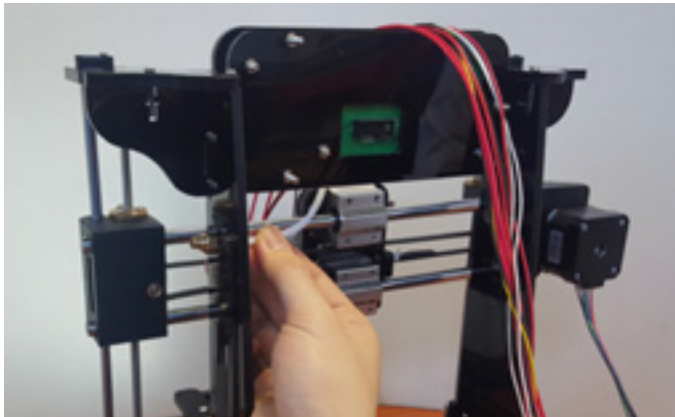

2) Secure the Extruder Motor with M3 10mm Screws x2.

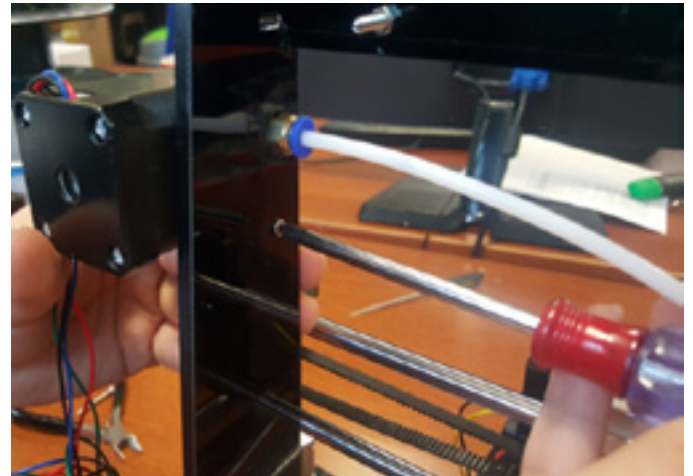



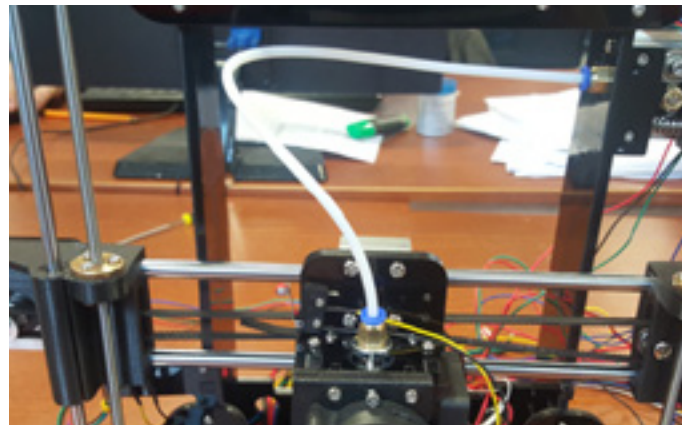

3) Insert the Teflon Tube into the Hot End.



Step 24: Install PCB board (4 - 6 mins)



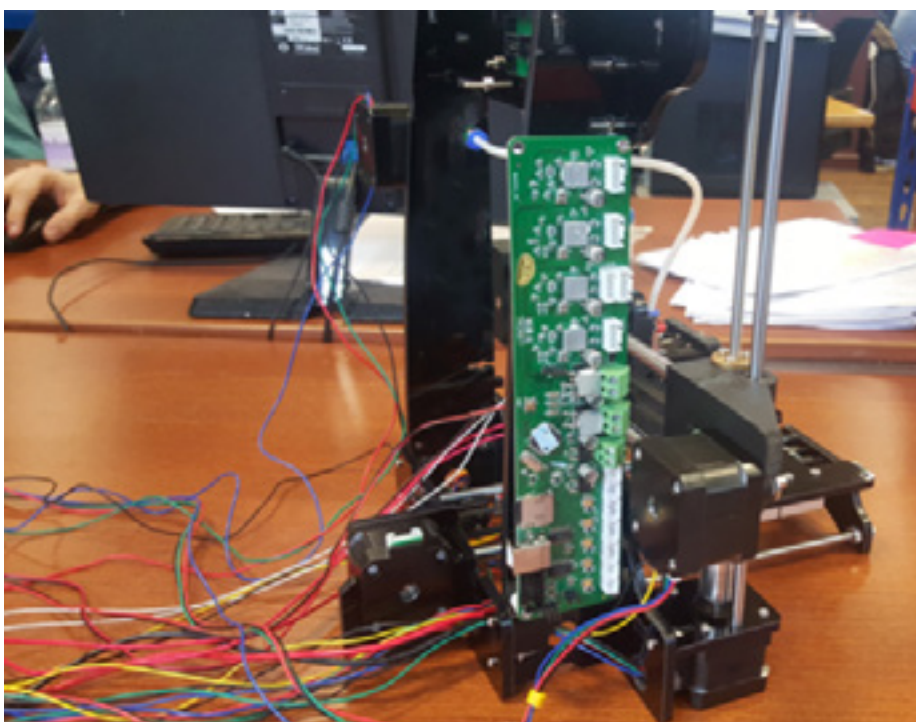
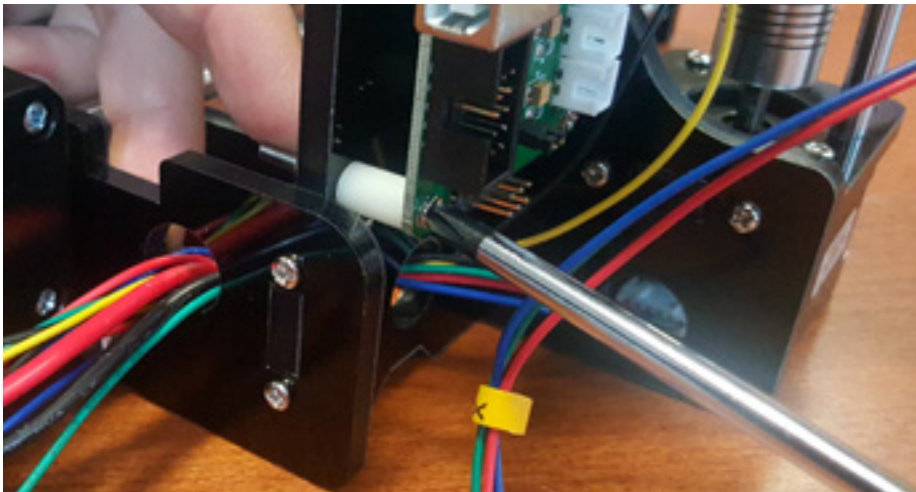

Parts Required

		
	Plastic Spacer x3	M3 Nut x3
		
PCB Board	M3 25mm Screw x3	

- 1) Insert the Plastic Spacer in between the side plate and the PCB Board. Securing it with M3 25mm Screw x3 and M3 Nut x3 at the back.

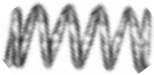

Step 25: Assemble bed (6 - 8 mins)

Parts Required		
		
	Thumb Nut x4	M3 Nut x 4
		
Bed	Spring x4	M3 25mm Screw x4

1) Insert the screws into the Bed. **Notice the face of the bed with special gap for the screw.**

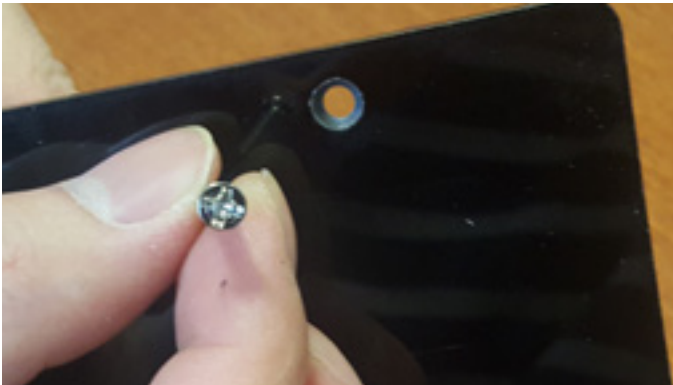

2) Secure all four screws with M3 Nuts.

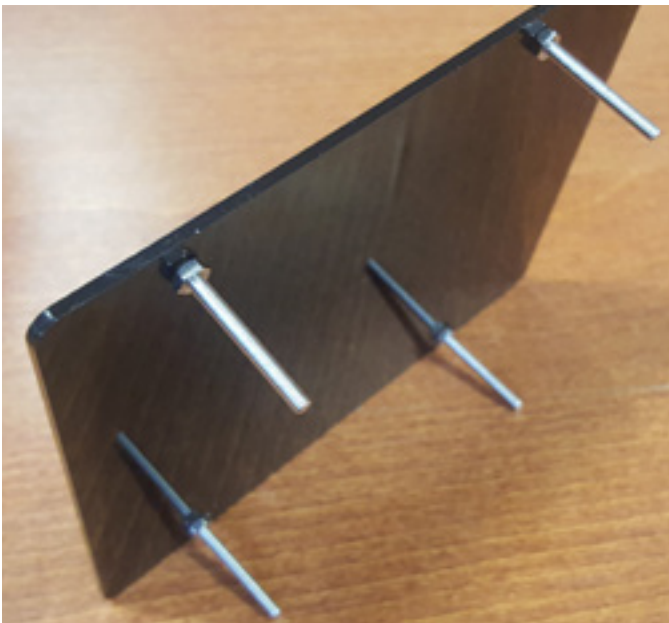

3) To raise the Hot End, rotate both of the couplers to the same direction which will move the Hot End upward to approximately same height as shown in the picture.

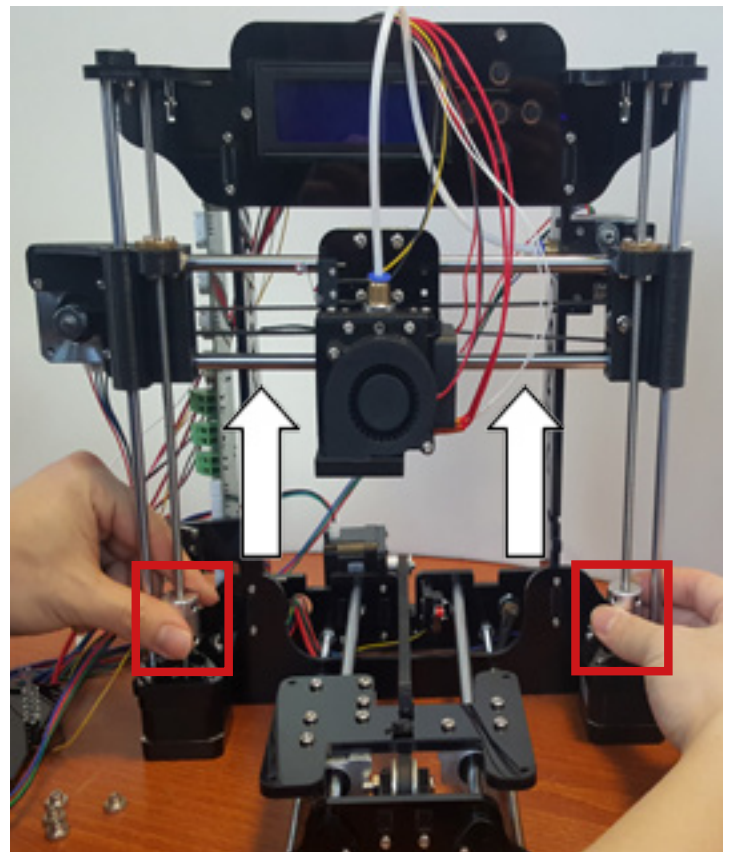

4) Place the springs on the Y-Carriage. Put the bed on top and secure them all with Thumb Nuts underneath.

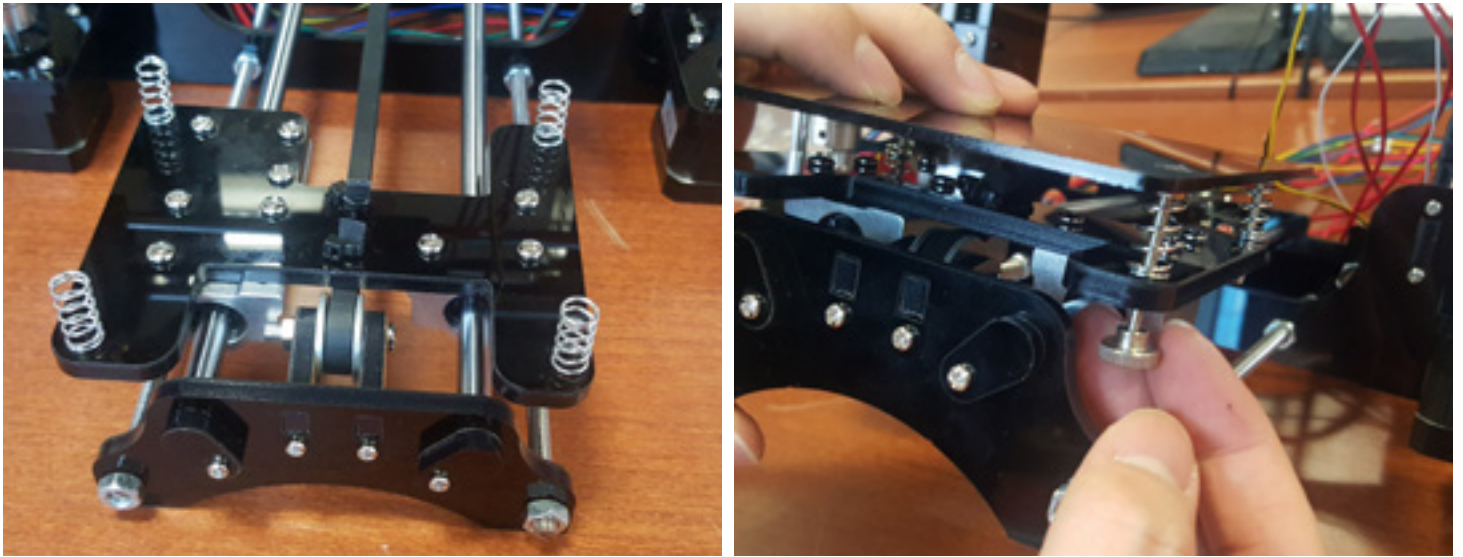

5) Rotate all Thumb Nuts to make sure they have approximately similar height.

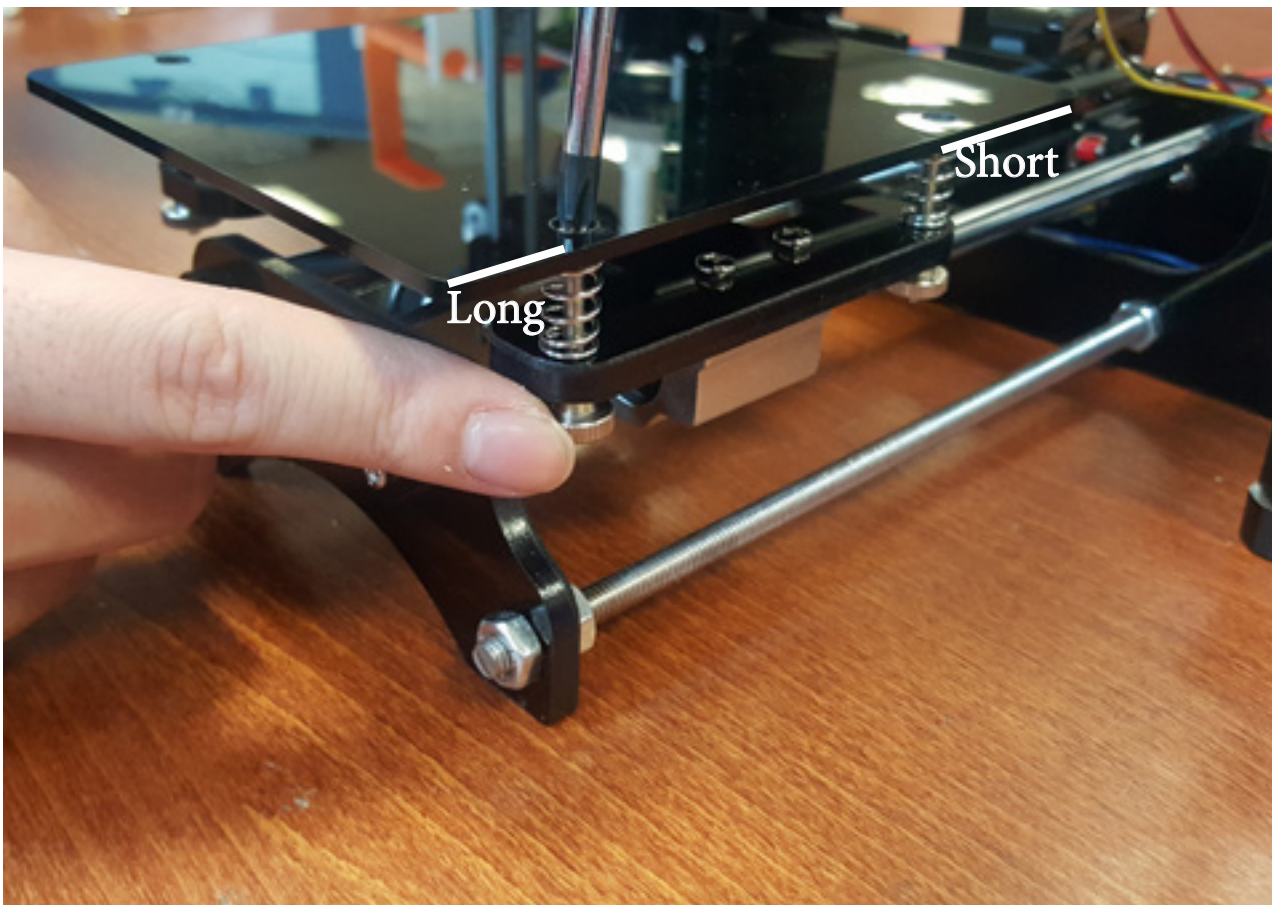

Step 26: Plug in Wire for Y-Motor and Screen (1 - 2 mins)

Parts Required



Screen Cable



'Y' Motor Wire (Short)

1) Plug the Screen Cable to the back of the screen. **Make sure the red line on the cable is on the left.**

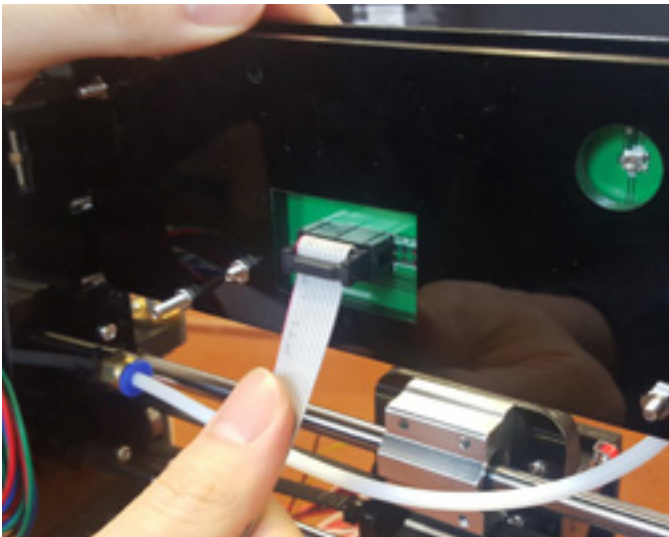

2) Attach the other side of the cable to the PCB board. **Make sure the red line is on the top.**

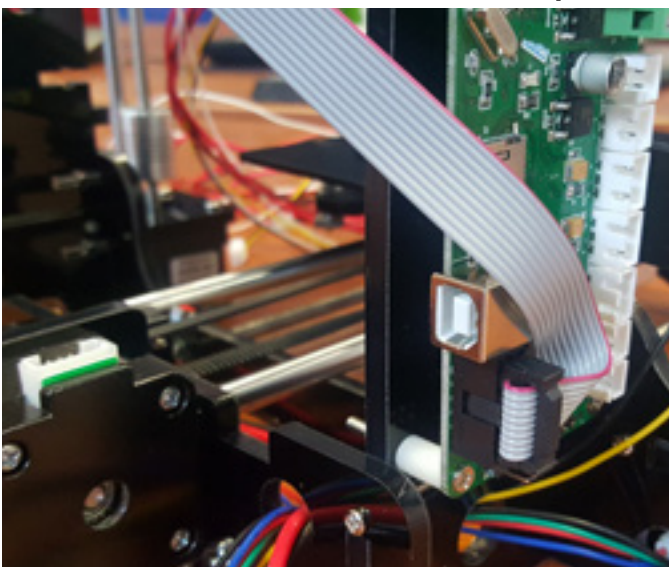

3) Attach the Y labelled cable to the Y-Axis Motor. **Please label the wires if it hasn't been labelled yet.**

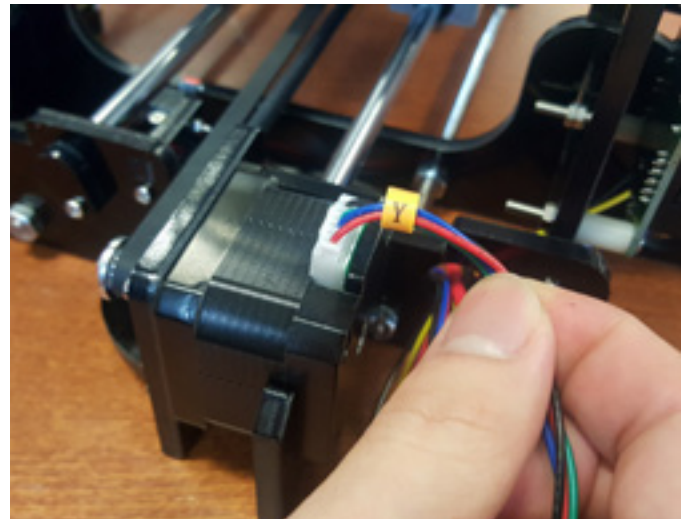

Step 27: Connecting Wires to the PCB Board (1 - 4 mins)

Parts Required



Black Spiral Wrap

1) Locate the motor cable labelled 'X' and attach to the white connector on the PCB board as shown in the picture below.

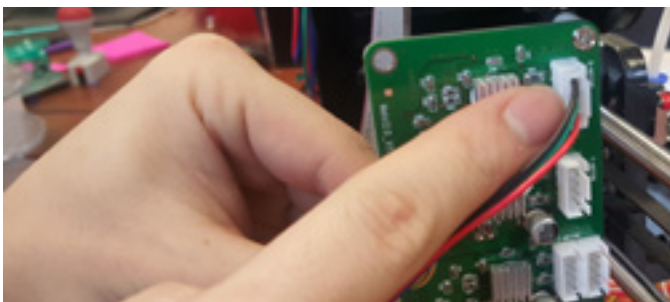
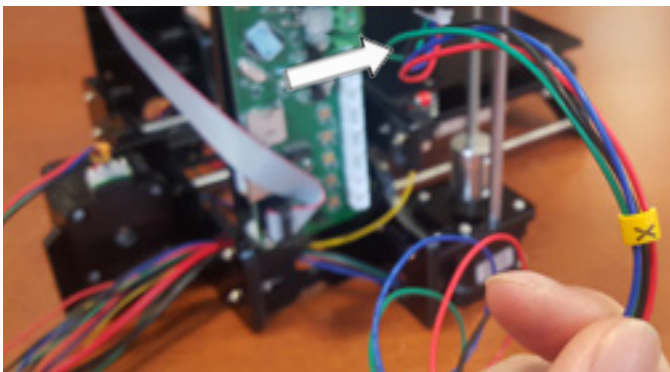

2) Connect 'Y' labelled motor wire to the second white connector.

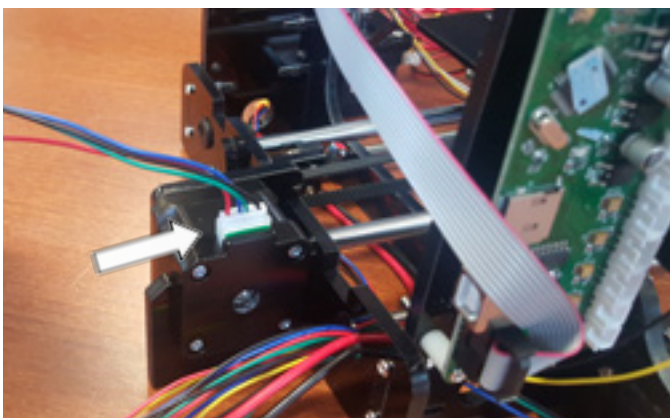

3) From the hole on the back plate, locate Z1 and Z2 labelled wires. Connect both wires to the white connectors as shown in the picture. **Connect wire 'Z1' to the left connector and wire 'Z2' to the right connector.**

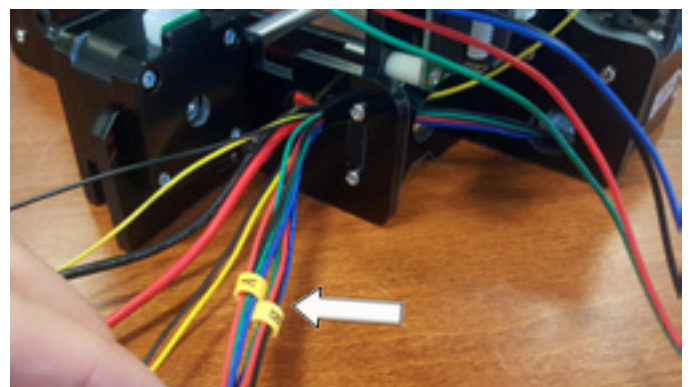

4) Connect the 'E' labelled wire to the next white connector.

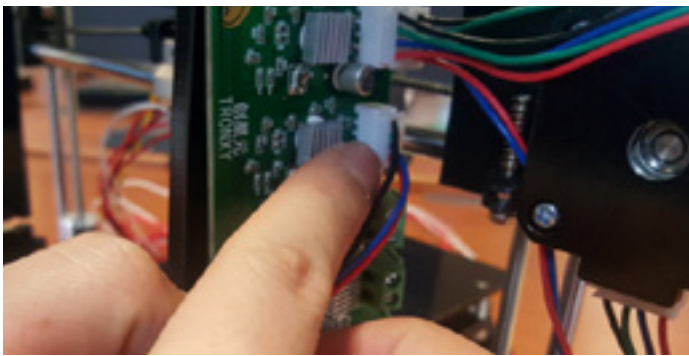
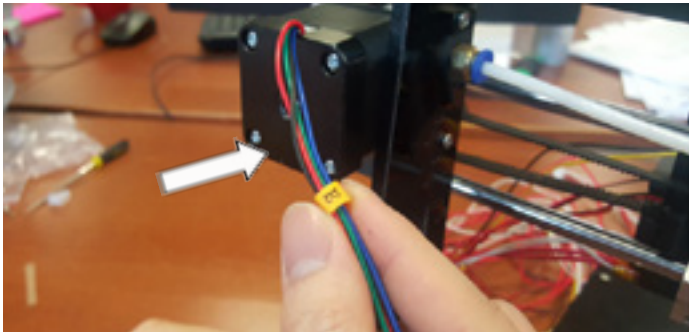

5) Locate the two fat black and red wires from the hole of the back plate. Connect them to the first green connector using the provided flat head screw driver as shown in the picture below. **Red wire for the top and black for bottom.**



6) Locate the pair of red wire from the Hot End and connect them to the last green connector. Orientation of the wire does not matter. **Make sure to pass all the wires from the Hot End from the top of the printer to the PCB board.**

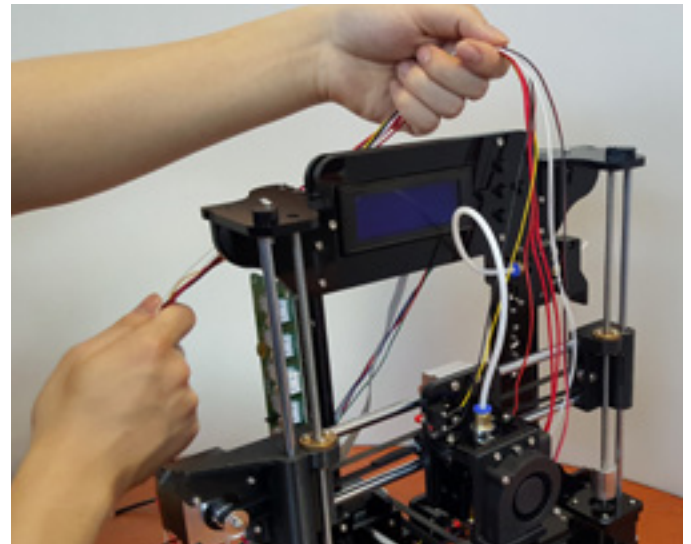
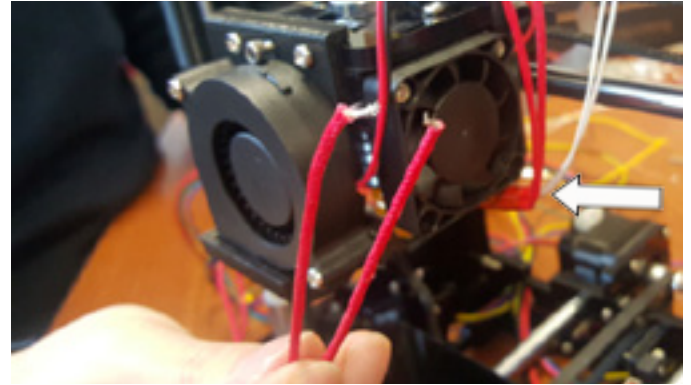

7) Locate the red/black wire from the big fan of the Hot End and connect it to the white connector on the PCB board.

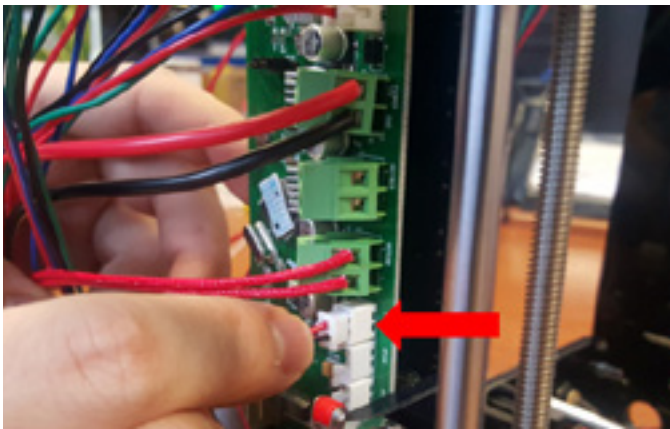
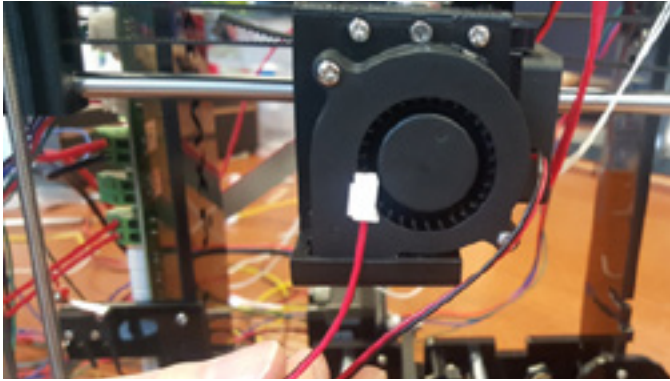

8) Locate the red/black side fan cable from the Hot End. Connect it to the next white connector.

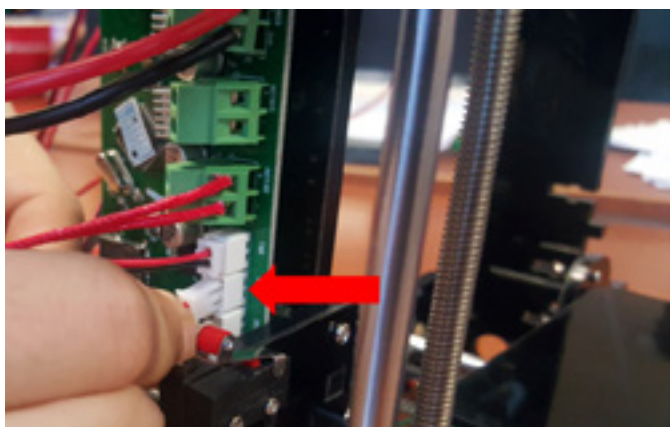
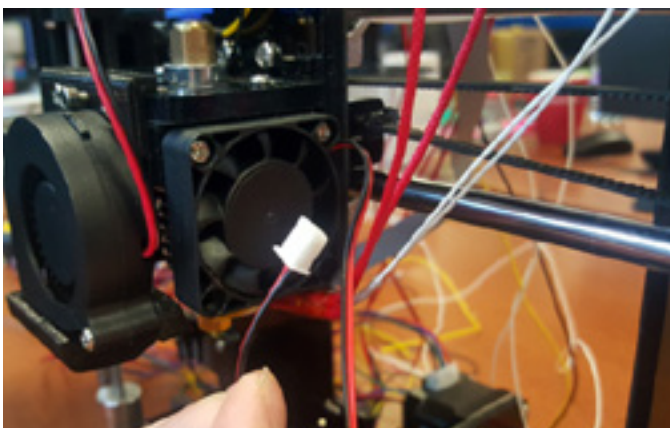

9) Locate the yellow/black connector from the X-Axis Limit Switch (this is connected to the Hot End). Connect it to the next white connector.

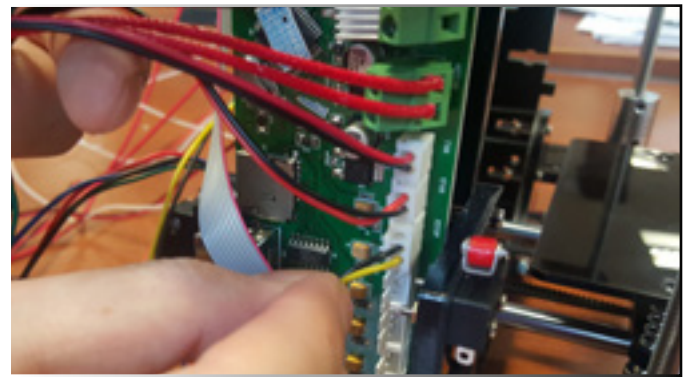
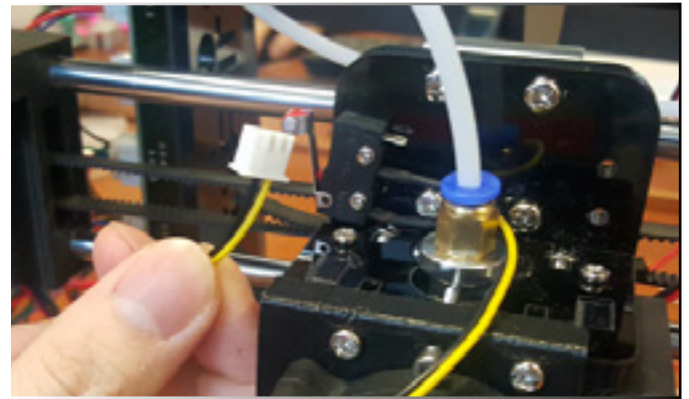

10) Locate the yellow/black wire from the Y-Limit Switch (this is the one attached to the Back Base Frame). Connect it to the next white connector.

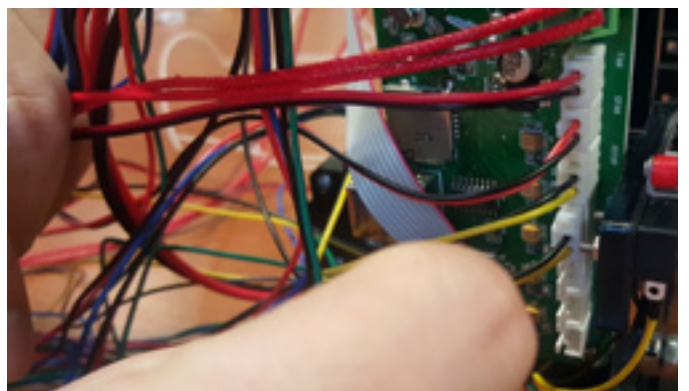
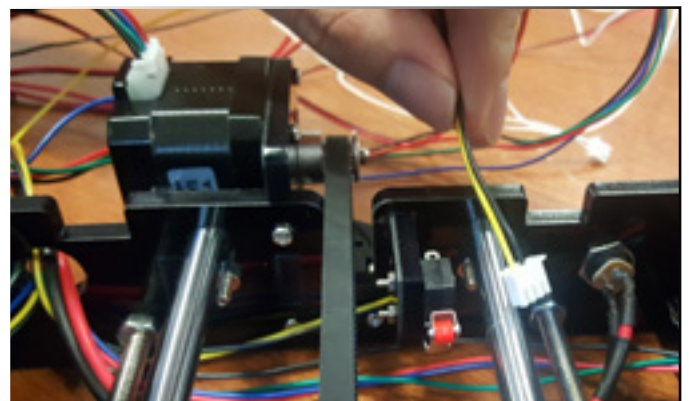

11) Locate the yellow/black wire from the Z-axis limit switch (this is the one nearest to the PCB board). Connect it to the next white connector.

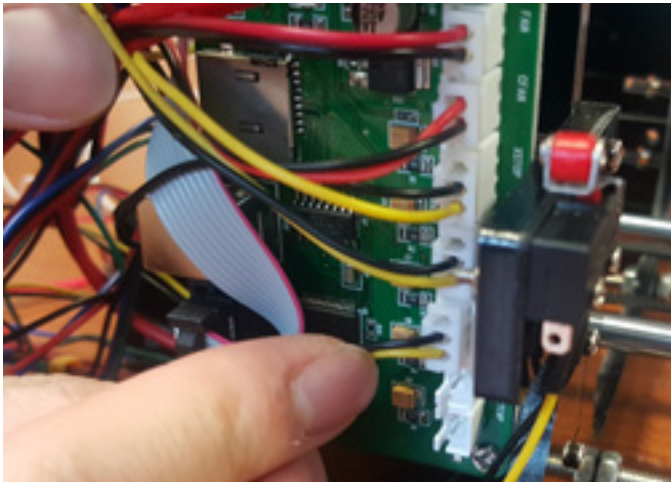
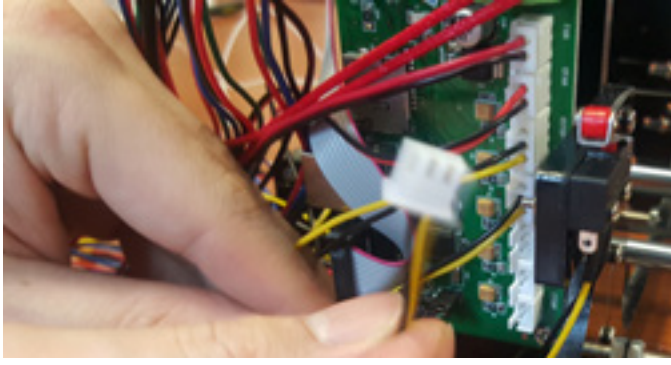

12) Locate the white cable for the thermistor from the Hot End. Connect it to the last white connector.

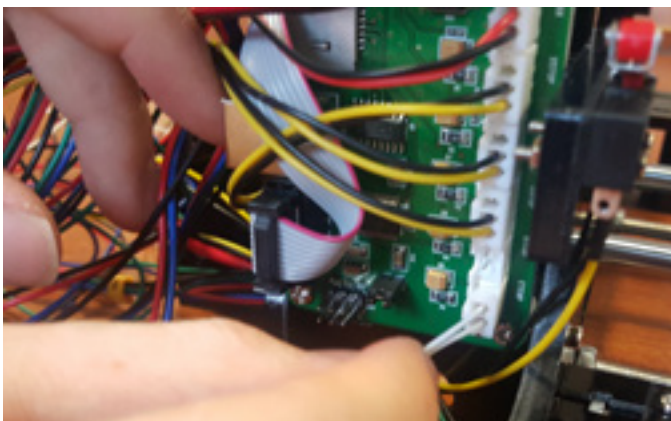
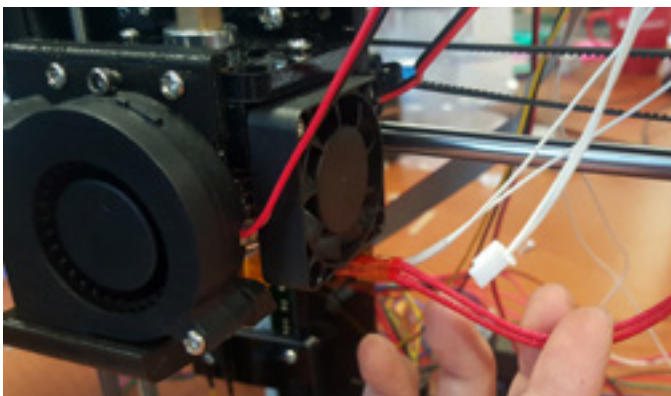

13) Wrap the wires from the Hot End with the Black Spiral Wrap.

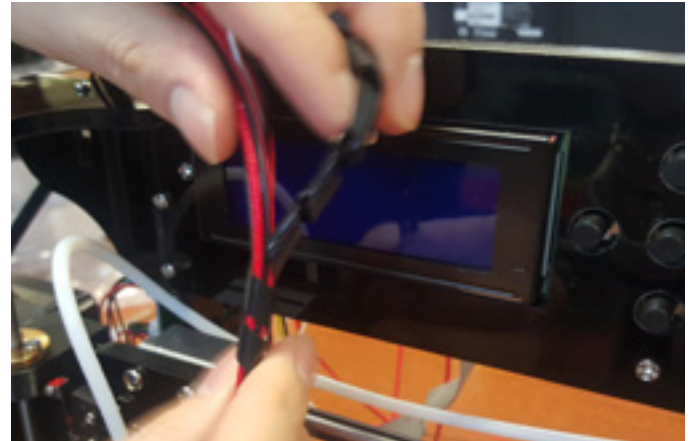

14) You can wrap the other cables to tidy up the messy wires if you wish to.

Complete

Congratulations!! You have now completed building the STARTT printer. Please visit [this link](#) for the calibration video. Once it's properly calibrated, you can start printing.

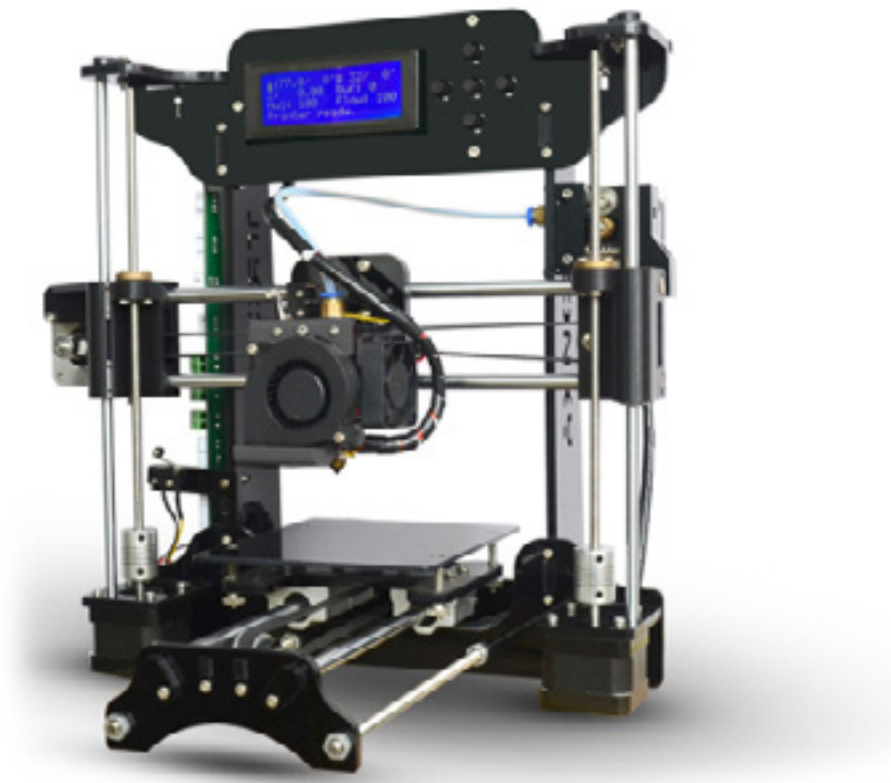

MyMiniFactory

Who are we?

MyMiniFactory is the world leading 3D printable object-sharing platform. Thousands of talented designers for 3D printing upload and share files that can be downloaded for free. MyMiniFactory is an open platform, so you can share your own creations too! Every single file shared on MyMiniFactory has been guaranteed as 3D printable, so you can be sure to have a great experience when 3D printing an object with your STARTT 3D printer.

The files included on the SD card coming with your STARTT 3D printer have been downloaded from MyMiniFactory. You can find more than 20,000 files, so you'll be having lots of fun with your 3D printer.

Check out our website at www.MyMiniFactory.com to see all the cool 3D prints you can make. You will also find on the [STARTT profile page](#) a collection of recommended objects and examples of prints.